

1a IR INRUSH CURRENT PROTECTION

OPTIONAL CONTROL FEATURE

With the Inrush Current Protection (IR) Control, when the power switch is turned on to supply current to the fan, the current is zero and starts to increase gradually until the fan has achieved its maximum speed at the rated current. The maximum current at startup is equal to the free-running current (or less when the rotor stays locked at startup). The fan will achieve the rated speed within 10 seconds. This built-in Control contains no external wire. **End Result Benefit:** Protects from Current surges.

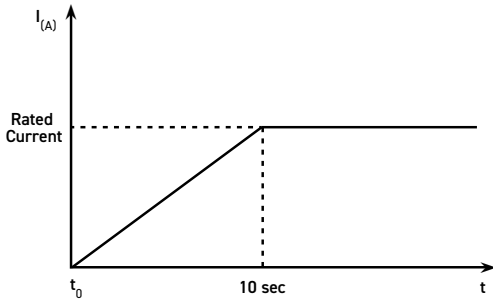

1b AS AUTO RESTART

STANDARD CONTROL FEATURE

The Auto Restart (AS) Control feature ensures that the fan will automatically restart if the blade is blocked and then released. When the rotor is locked, the fan current is reduced to zero and the fan tries to restart every 5 seconds. This is a built-in Control with no external wire. **End Result Benefit:** Protects automatically if the blade gets blocked.

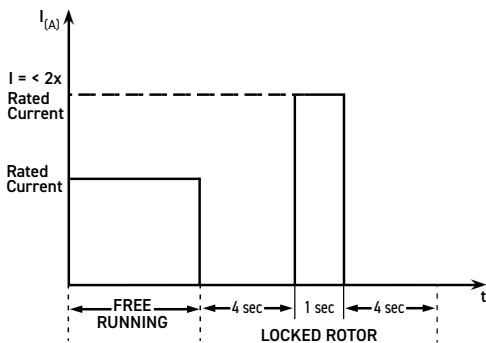

2a FG TACHOMETER (FREQUENCY GENERATOR)

OPTIONAL CONTROL FEATURE

The Frequency Generator (FG) Control is an open collector output type. It provides a square wave signal if the open collector is connected to a "PULL UP" resistor and is powered by the power supply voltage which is compatible with the input of the reading device (such as TTL input of the computer etc.). The maximum collector voltage may be up to 72V DC and the maximum collector current is 10mA. The reading device's power supply must have the same ground potential as the fan. The FG Control is an external YELLOW wire. **End Result Benefit:** Monitors the fan's running speed.

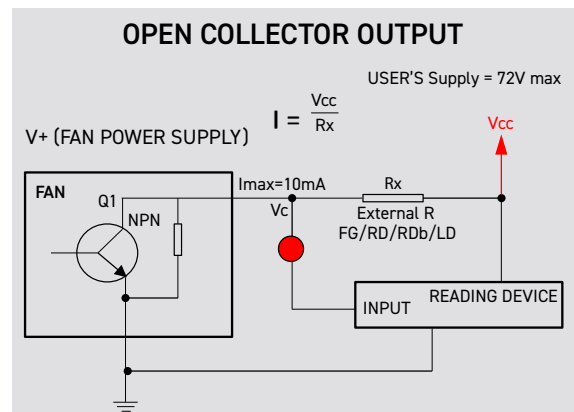
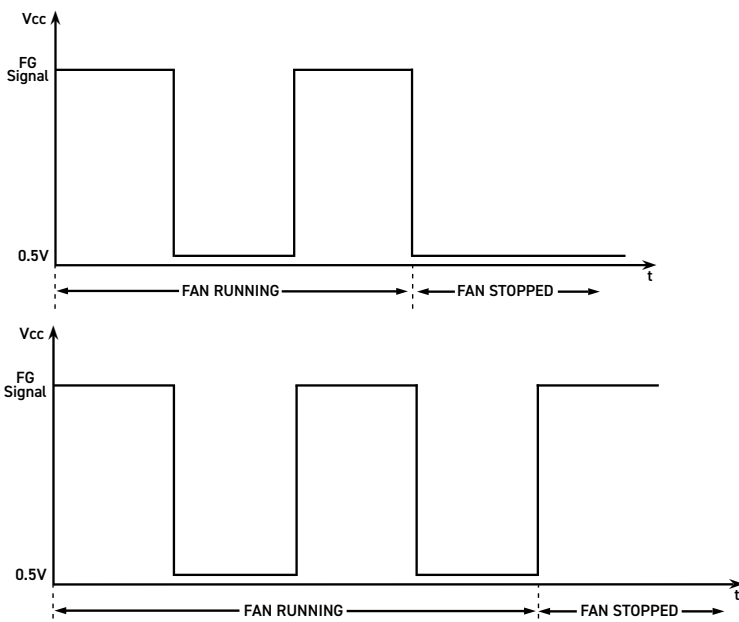

2b RD ROTATION DETECTION **OPTIONAL CONTROL FEATURE**

The Rotation Detection (RD) Control is an open collector type. It contains the same hardware as the Frequency Generator Control 2a. The output signal is LOW when the fan is rotating and is set HIGH when the fan is stopped or is powered OFF. The RD Control is an external GRAY wire. **End Result Benefit:** Indicates if the blade is rotating (LOW signal).

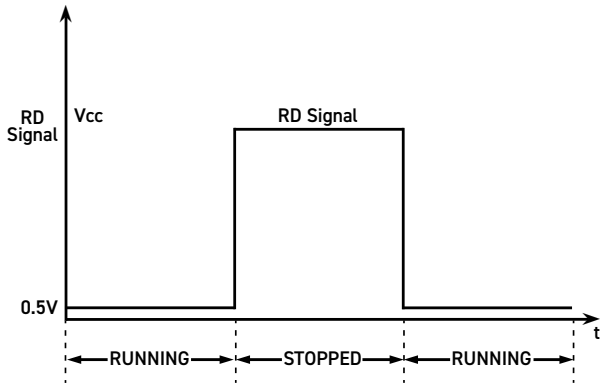

2c RDb ROTATION DETECTION COMPLEMENT **OPTIONAL CONTROL FEATURE**

The Rotation Detector Complement (RDb) Control is an open collector type with the same hardware as the Frequency Generator Control 2a. The output signal is HIGH when the fan is rotating and is set LOW when the fan is stopped or is powered OFF. This output can be connected in parallel to the RDb of an array of fans that ends at a single alarm device to warn when any fan has stopped (see the Multi-Fan Alarm Connection on page 63). The RDb Control is an external VIOLET wire. **End Result Benefit:** Indicates if the blade is rotating (HIGH signal).

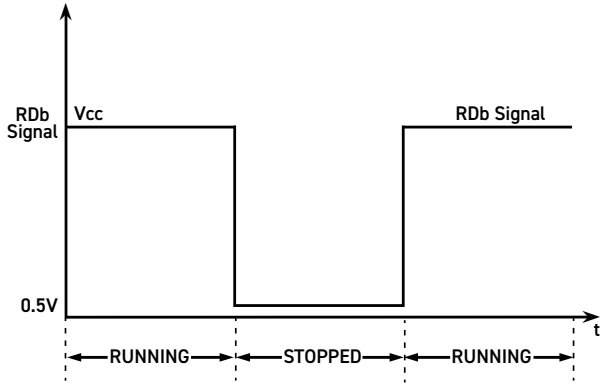

2d LD LIFE DETECTION **OPTIONAL CONTROL FEATURE**

The Life Detection (LD) Control is an open collector type with the same hardware as the Frequency Generator Control 2a. The output signal is HIGH when the fan is rotating normally and it is LOW when the fan is turning below 70% of its rated target speed. Slow rotation may indicate aging or wear of the fan or reduced power supply voltage. The LD Control is a BROWN external wire. **End Result Benefit:** Indicates if the blade is rotating (HIGH signal).

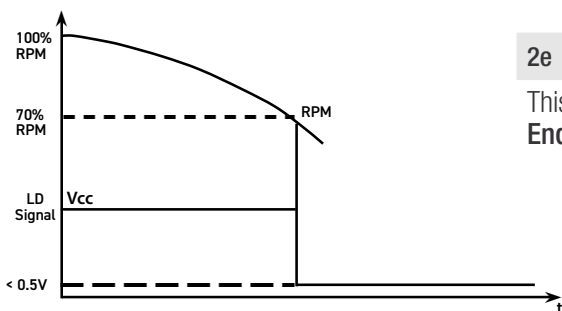

2e LDb LIFE DETECTION COMPLEMENT **OPTIONAL CONTROL FEATURE**

This function is the complement of the LD Control applied in one fan. **End Result Benefit:** Indicates if the blade is rotating (LOW signal).

3a VPWM DC VOLTAGE SIGNAL CONTROL

OPTIONAL CONTROL FEATURE

The DC Voltage Signal (VPWM) Control adjusts the speed when applying an external DC Voltage signal. This voltage input “Vin” may have any value from 1V to 20V (standard value is 1V to 5V). The blower speed will vary linearly and is proportional to the % change of the “Vin” value, corresponding to the same % change of the maximum speed.

The Constant Speed (CS), Inrush Current Protection (IR), and Current Limit (CL) controls are included. The part number is followed by additional identification entry such as V 1 5 20 100 C 500: This means the fan speed will be 1,000 RPM (20%) at 1V and 5,000 RPM (100%) at 5V. The fan will maintain the minimum speed if Vin < 1V and it will stop if Vin < 0.5V (Mode “C” operation). The maximum fan speed is 5,000 RPM, and the stop point is typically set at 20% of the maximum. The VPWM Control is an external WHITE wire. (See Mode A, B, C) Slope: 1,000 RPM/Volt. **End Result Benefit:** Controls speed via an external DC voltage signal.

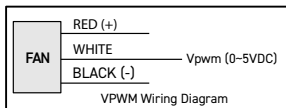

VPWM-pos-slope 2008/7/16
RPM: 882 to 5000
Vs: 1.8 to 10 Volts
VPWM 1.8 10 18 100 A 500
MODE: TYPE- A change @: -0.2 V
ST 12% 1.65 D 0.2 F 2 C

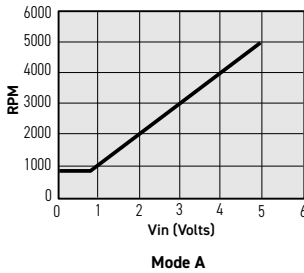

VPWM-pos-slope 2008/7/16
RPM: 882 to 5000
Vs: 1.8 to 10 Volts
MODE: TYPE- B change @: 1.78 V
VPWM 1.8 10 18 100 B 500
ST 12% 1.65 D 0.2 F 2 C

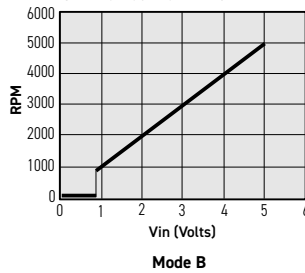

VPWM-pos-slope 2008/7/16
RPM: 882 to 5000
Vs: 1.8 to 10 Volts
VPWM 1.8 10 18 100 C 500
MODE: TYPE- C change @: 0.8 V
ST 12% 1.65 D 0.2 F 2 C

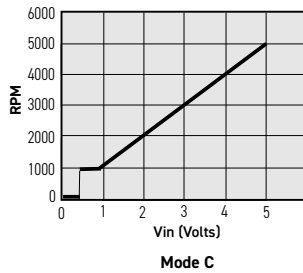

* Select from Mode A, Mode B, or Mode C, or specify required function.

3b IPWM CURRENT SOURCE SIGNAL CONTROL

OPTIONAL CONTROL FEATURE

The Current Source Signal (IPWM) Control adjusts the speed by applying an external Current Source Signal. This current input “Iin” may have any value from 4 mA to 50 mA, (standard value is 4 to 20mA). The fan speed will vary linearly and is proportional to the % change of the Iin value, corresponding to the same % change of the maximum speed.

The Constant Speed (CS), Inrush Current Protection (IR), and Current Limit (CL) controls are included. The part number is followed by additional identification entry such as I 4 20 20 100 A 500. This means that the fan speed will be 1,000 RPM (20%) at 4mA and 5,000 RPM (100%) at 20mA. The fan will maintain the minimum speed if Iin < 4mA (Mode “A” operation). The maximum fan speed is 5,000 RPM. The IPWM Control is an external WHITE wire. (See Mode A, B, C) Slope: 266 RPM/mA.

End Result Benefit: Controls speed via an external Current source signal.

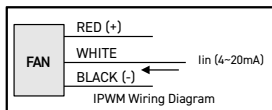

IPWM
RPM: 1000 ~ 5000
I in: 4.0 ~ 20.0mA
MODE: TYPE-A Stop @: 0.0mA
IPWM 4 20 20 100 A 500

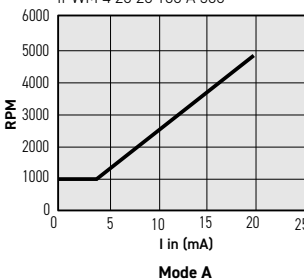

IPWM
RPM: 1000 ~ 5000
I in: 4.0 ~ 20.0mA
MODE: TYPE-B Stop @: 4.0mA
IPWM 4 20 20 100 B 500

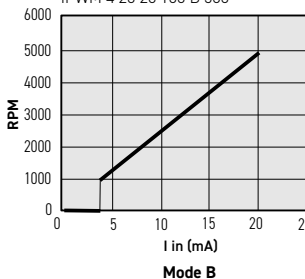

IPWM
RPM: 1000 ~ 5000
I in: 4.0 ~ 20.0mA
MODE: TYPE-C Stop @: 1.96mA
IPWM 4 20 20 100 C 500

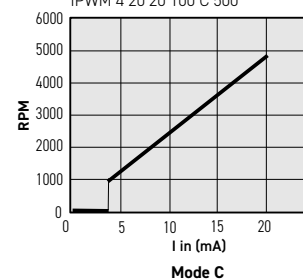

* Select from Mode A, Mode B, or Mode C, or specify required function.

3c PPWM PULSE WIDTH MODULATION SIGNAL CONTROL

OPTIONAL CONTROL FEATURE

The Pulse Width Modulation Signal (PPWM) Control adjusts the speed by applying a pulse width modulated signal. The frequency may be in the range of 30 Hz to 30 KHz. The maximum pulse height “HIGH” may be from 3V to 10V. The maximum pulse height “LOW” is 0.4V. The fan speed will vary linearly and is proportional to the % change of the Duty Cycle value, corresponding to the same % change of the maximum speed.

The Constant Speed (CS), Inrush Current Protection (IR), and Current Limit (CL) controls are included. The part number is followed by additional identification entry such as P 25 80 25 80 C 393 Cs320. This means that the fan speed will be 1,000 RPM (25%) at 25% Duty Cycle and 3,200 RPM (80%) at 80% Duty Cycle. Furthermore, the fan will maintain the minimum speed if the Duty Cycle is less than 25% (Mode “A” operation). The maximum possible fan speed is 4,000 RPM. (See Mode A, B, C) Slope: 36.4 RPM/%P-**WM. End Result Benefit:** Controls speed by applying a PWM signal 30Hz to 30KHz.

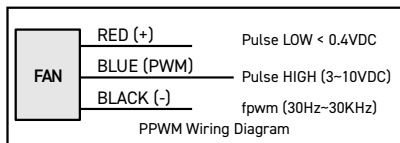

PPWM-pos-slope 2008/7/15

RPM: 988 to 3200
 %PPWM 24.7% to 80.0%
 MODE: TYPE- A change @: -2.0%
 PPWM 24.8 80 25 80 A 320 CN-010-012
 ST 12% 1.65 D 0.2 F 2 C - CN-010-012

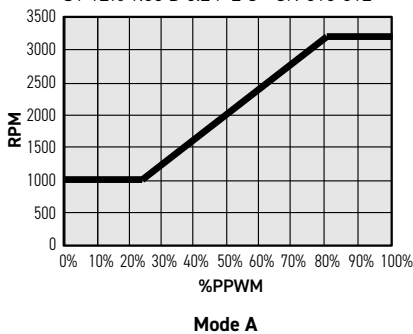

PPWM-pos-slope 2008/7/15

RPM: 988 to 3200
 %PPWM 24.7% to 80.0%
 MODE: TYPE- B change @: 25.0%
 PPWM 24.8 80 25 80 B 320 CN-010-012
 ST 12% 1.65 D 0.2 F 2 C - CN-010-012

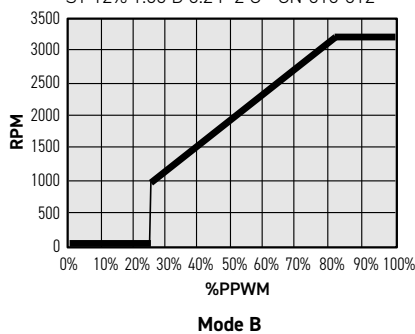

PPWM-pos-slope 2008/7/15

RPM: 988 to 3200
 %PPWM 24.7% to 80.0%
 MODE: TYPE- C change @: 10.0%
 PPWM 24.8 80 25 80 C 320 CN-010-012
 ST 12% 1.65 D 0.2 F 2 C - CN-010-012

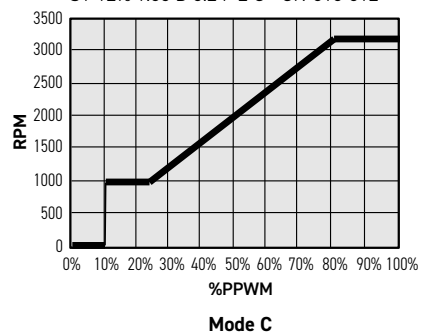

* Select from Mode A, Mode B, or Mode C, or specify required function.

4 OV OVER VOLTAGE PROTECTION

OPTIONAL CONTROL FEATURE

This Over-Voltage Protection (OV) Control detects the power supply voltage and allows operation up to the rated maximum operating voltage. Typically, the maximum operating voltage is 20% over the specified rated voltage (unless otherwise specified).

If the power supply voltage increases over the 20% limit, the fan will stop running and the power supply current will be reduced to essentially zero. The maximum over-voltage protection range is twice the value of the rated voltage. For example, if the rated voltage is 24V, the maximum voltage that can be applied accidentally is 48V. The same applies to a 12V blower; the maximum applied over-voltage is 24V. The OV Control comes built-in with no external wire. **End Result Benefit:** Protects from power supply over-voltage.

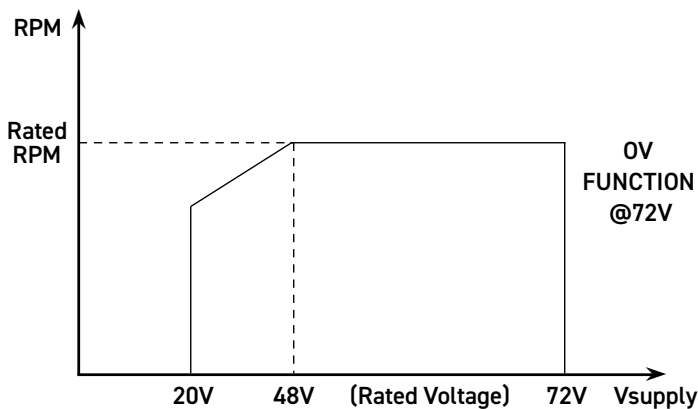

5a TPWM AUTOMATIC TEMPERATURE CONTROL

OPTIONAL CONTROL FEATURE

When the Automatic Temperature (TPWM) Control is applied, the upper and lower temperatures may be selected as well as the choice of maintaining the minimum RPM below the minimum temperature chosen. The Constant Speed (CS), Inrush Current Protection (IR), and Current Limit (CL) controls are included.

The NTC thermistor is a 104J (100K @ 25 °C) type and is included with the fan (either “built-in” or external). The part number is followed by additional identification entry such as T 16 40 20 100 A 500. This means that the fan speed will be 1,000 RPM (20%) at 16 °C and 5,000 RPM (100%) at 40 °C. The fan will maintain the minimum speed of 1,000 RPM below the temperature of 16 °C (Mode “A” operation). For safety reasons, if the NTC thermistor is OPEN or SHORTED, the fan will run at its maximum speed. The TPWM Control is an external GREEN wire. Mode A, B, and C show the three available modes of control.

End Result Benefit: Controls speed automatically via a temperature sensor.

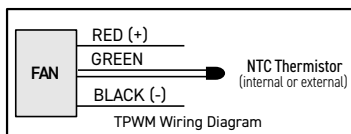

TPWM (ntc to GND) 07/16/08

RPM: 1000 to 5000
 MODE: A
 TPWM (ntc to GND) 15 40 20 100 A 500
 Temp.(°C) 15.0 to 40.0
 ST 6% 1.65 D 0.2 F 1 A - CN-010-021

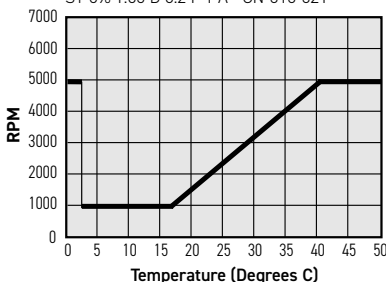

Mode A

TPWM (ntc to GND) 07/16/08

RPM: 1000 to 5000
 MODE: B
 TPWM (ntc to GND) 15 40 20 100 B 500
 Temp.(°C) 15.0 to 40.0
 ST 6% 1.65 D 0.2 F 1 A - CN-010-021

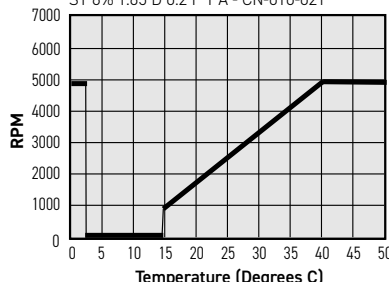

Mode B

TPWM (ntc to GND) 07/16/08

RPM: 1000 to 5000
 MODE: C Stop @: 5 °C
 TPWM (ntc to GND) 15 40 20 100 C 500
 Temp.(°C) 15.0 to 40.0
 ST 6% 1.65 D 0.2 F 1 A - CN-010-021

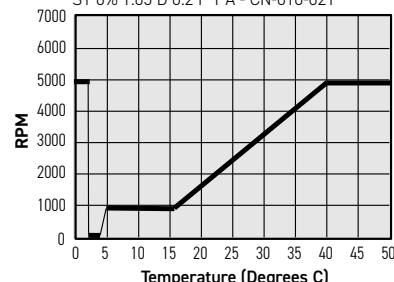

Mode C

* Select from Mode A, Mode B, or Mode C, or specify required function.

5b RPWM MANUAL VARIABLE RESISTOR CONTROL **OPTIONAL CONTROL FEATURE**

With the Manual Variable Resistor (RPWM) Control, the speed can be controlled using an external variable resistor. This resistor may have any maximum value from 10K to 100K. The fan speed will vary linearly and is proportional to the % change of the resistor value, corresponding to the same % change of the maximum speed.

The Constant Speed (CS), Inrush Current Protection (IR), and Current Limit (CL) controls are included. The part number is followed by additional identification entry such as R 25 100 25 100 B 400. This means if VR = 100K, the blower speed will be 1,000 RPM (25%) at VR = 25K and 4,000 RPM. (100%) at VR = 100K. The fan will stop if VR < 25K (Mode “B” operation). The maximum fan speed is 4,000 RPM. The RPWM Control is an external ORANGE and WHITE wire. (See Mode A,B, C) Slope: 40 RPM / %R, (If VR=10K: 400 RPM/KΩ, If VR=50K: 80 RPM/KΩ).

End Result Benefit: Controls speed manually via an external resistor.

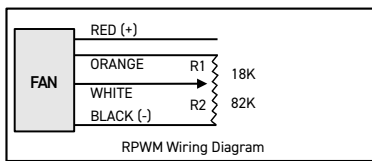

RPWM-pos-slope 2008/7/16
 RPM: 988 to 4000
 %R= 24.7% to 100.0%
 RPWM 24.8 100 25 100 A 400
 ST 12% 1.65 D 0.2 F 2 C - CN-010-013
 MODE: TYPE- A change @: -2.0%

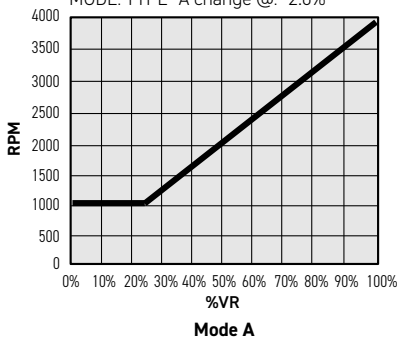

RPWM-pos-slope 2008/7/16
 RPM: 988 to 4000
 %R= 24.7% to 100.0%
 RPWM 24.8 100 25 100 B 400
 ST 12% 1.65 D 0.2 F 2 C - CN-010-013
 MODE: TYPE- B change @: 25.0%

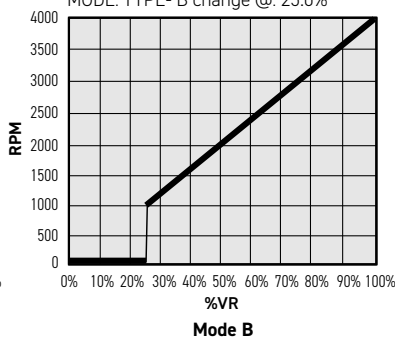

RPWM-pos-slope 2008/7/16
 RPM: 988 to 4000
 %R= 24.7% to 100.0%
 MODE: TYPE- C change @: 10%
 RPWM 24.8 100 25 100 C 400
 ST 30% 2 D 3.2 F 3 fD - CN-010-032

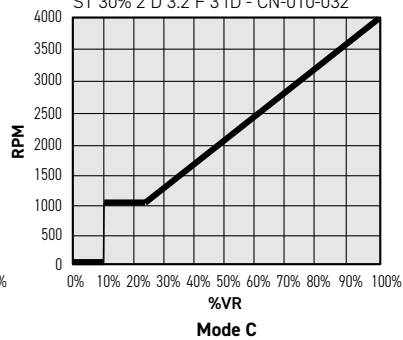

* Select from Mode A, Mode B, or Mode C, or specify required function.

6 CL CURRENT LIMIT CONTROL **OPTIONAL CONTROL FEATURE**

With the Current Limit (CL) Control, the current is limited during the start or restart (AS) period (refer to the Auto Restart feature on page 6). The CL Control comes built-in with no external wire.

End Result Benefit: Limits Current during start or restart period.

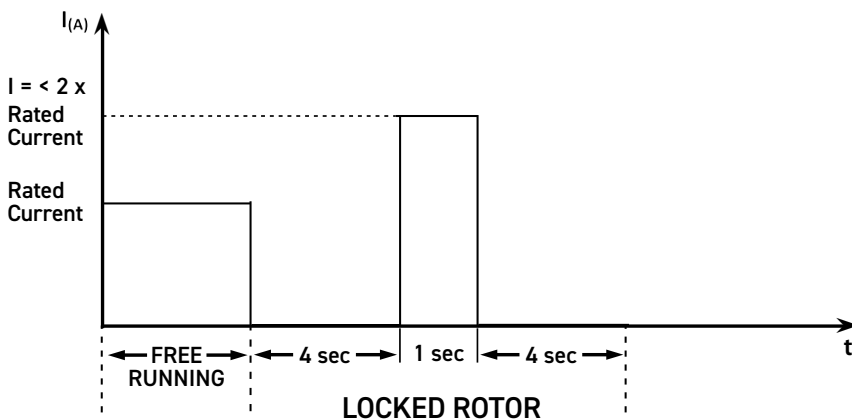

7 CS_f FIXED CONSTANT SPEED

OPTIONAL CONTROL FEATURE

The Fixed Constant Speed (CS_f) Control allows the fan to operate safely over a very large power supply voltage range. For example, if the fan is designed to run at 4,200 RPM at the rated voltage of 48 Volts, the fan will maintain the same RPM even when the supply voltage varies from 48 to 72 Volts.

The fixed CS Control is preset internally and the maximum RPM is the rated RPM. The Fixed CS Control is built-in with no external wire. **End Result Benefit:** Maintains a constant speed over a wide voltage range.

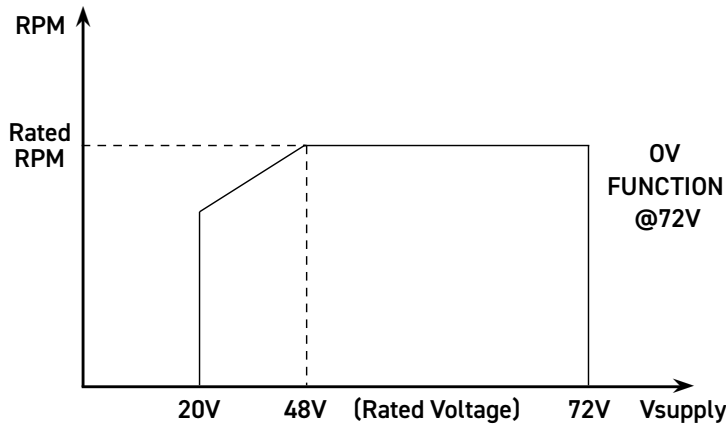

7a CS_p PROGRAMMABLE CONSTANT SPEED

OPTIONAL CONTROL FEATURE

The Programmable Constant Speed (CS_p) Control can be implemented by the use of the RPWM Control. For example, if the external resistor is made up by an 82K and an 18K resistor, then the center point of these resistors will be the input which will determine that 82% of the rated speed will be the maximum speed of the modified fan (if the resistor ends are reversed, then 18% of the rated speed will be the new maximum speed).

The resistor ends are tied to the ORANGE and BLACK wires and the center point is tied to the WHITE input wire. A very important use of this control is to overcome system impedance variations. The fan can be programmed to run at 20% lower of the rated speed at zero pressure. When the fan's static pressure is increased, the fan will be able to maintain the same speed under maximum pressure, thus becoming immune to system impedance variations. The Programmable CS Control is an external ORANGE and WHITE wire. **End Result Benefit:** Maintains a constant speed over a wide voltage range.

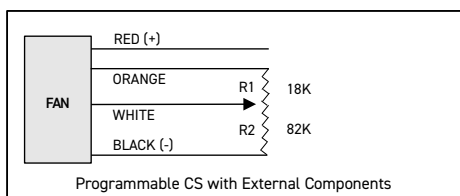

Q1 is the maximum airflow without CS adjustment.
 Q2 is the maximum airflow reduced with R1 and R2 setup.
 P2, P1 when the maximum speed is selected to set Q2 at about 80% of Q1.

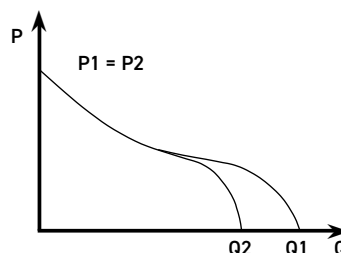
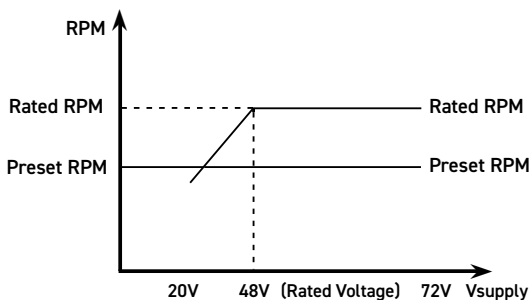

MULTI-FAN ALARM CONNECTION

OPTIONAL CONTROL FEATURE

When multiple fans are used in an application, it is critical to monitor the proper running state of the fans. It is practical to have a single alarm (sound or light) that will indicate when any of the fans have stopped running.

Every fan can include the Rotation Detector Complement (RDb) Control in order to combine the multi-alarm function to a single alarm indicator. The diagram below shows how to connect the multi-alarm any number of fans of any model equipped with the RDb Control cascaded (maximum 100 fans).

NOTE: If the engineer wants to connect to a voltage higher than 35V for his alarm signal, an R2 resistor may be added. If the fans have the Life Detection (LD) Control output and one fan runs below 70% of its rated speed, the alarm will be activated.

End Result Benefit: Monitors the running state of multiple fans.

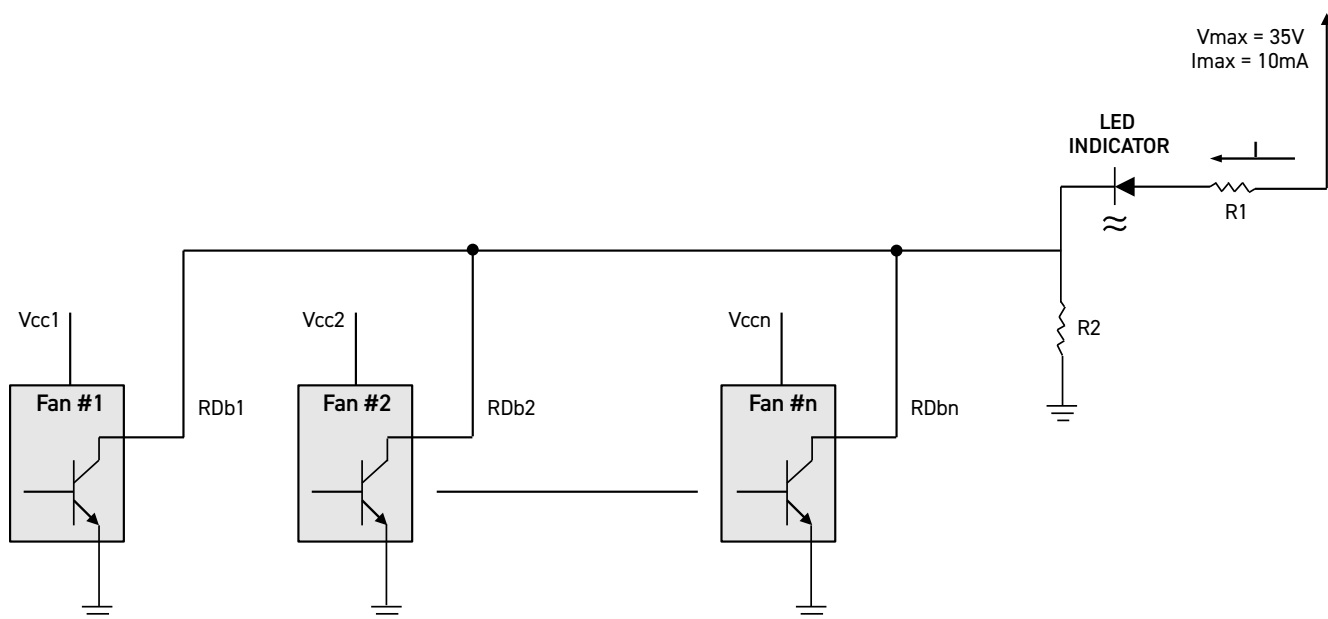

INGRESS PROTECTION (IP)

Ingress Protection (IP) indicates the level of protection against intrusion from dust and moisture.

IP51 (standard)	: Limited protection from dust and condensation.
IP54 (optional)	: Protection from dust and water spray from any direction.
IP56 (optional)	: Protection from dust and high pressure water jets from any direction.
IP67 (optional)	: Total protection from dust and water immersion.

HOW TO MEASURE THE IMPEDANCE OF YOUR SYSTEM

The measurement of the system's impedance and the selection of the appropriate fan can be illustrated by the following example:

Let us use a series 1232 blower with the following PQ characteristics:

P1232Y12BACB7b PQ Characteristics

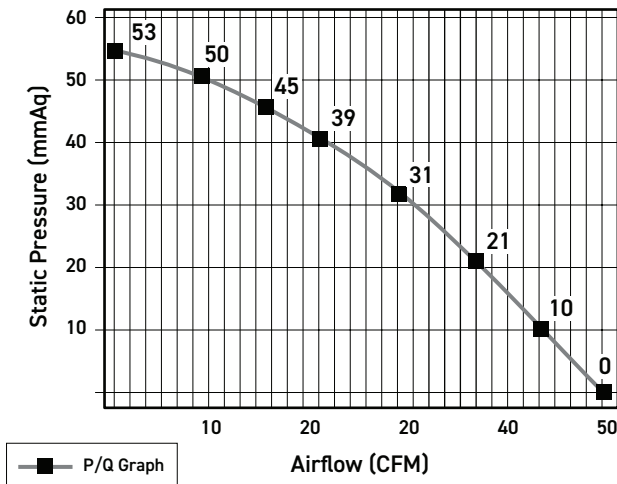

- A. Calculate the airflow through your system by applying the blower in your system and by measuring the incoming and outgoing airflow temperatures as follows:

$$\text{Airflow in CFM} = \frac{1.76 \times P}{T_2 - T_1}$$

Where: P = Input power into your system (e.g. 1000W)
 T2 = Outgoing airflow temperature in °C (e.g. 59.1°C)
 T1 = Incoming airflow temperature in °C (e.g. 20°C)
 Then, calculate the test result: Airflow = 45 CFM

- B. Refer to the PQ characteristic of the fan or blower to determine the static pressure of your system at the measured airflow. The pressure can be determined from the PQ graph above to be 6 mmAq, for the calculated airflow in A of 45 CFM.
- C. From the temperature specifications of your equipment, calculate the temperature difference T2-T1 where: T1 is the typical room temperature (e.g. 25° C) and T2 is the maximum allowable operating temperature of the equipment (e.g. 60° C). Therefore, T2-T1= 35° C. Assuming that you are powering your system with 1000W, necessary airflow can be calculated using the formula shown in A as follows:

$$\text{Airflow in CFM} = \frac{1.76 \times 1000}{35} = 50.3 \text{ CFM}$$

- D. For the purposes of the example used here, the appropriate fan to be selected for this application should be able to deliver a minimum of 50.3 CFM at a minimum static pressure of 6mmAq. For safety reasons and to allow for higher room temperature, referring to the product catalog, we can select model P1232Y that can deliver 64 CFM at 6 mmAq with 4200 RPM, or model P1238X that can deliver 63 CFM at 6 mmAq with 3650 RPM. We can further consider the noise level and product life.

In this case, model P1238X will be the optimum solution for the system outlined in the above example (See also "SELECTION OF A COOLING FAN" on page 1 and "AIRFLOW EFFICIENCY OF A FAN MOTOR" on pages 67-69).

METHOD OF DETERMINING LIFE EXPECTANCY

The life expectancy of a fan is limited by the following:

1. The **temperature** of the motor (i.e. Ambient temperature plus Temperature Rise of the motor) - for every 10°C increase of temperature, its life is decreased by 50%.
2. The **running speed** of the motor (for every 19% increase of speed, its life is decreased by 25%).
3. The **metal fatigue** of the bearing system used (e. g. The maximum bearing life is 70,000 hrs when the fan is running at 6000RPM as shown in the example below).
4. The **life of the electrolytic capacitor** whose value is decreased by 50% with every 10°C of temperature increase.

Below is a sample of MTBF (Mean Time Between Failure) calculation for fan model C6025X12BPCB2b-5. The calculation is based on tested samples C6025X12B-5, C6025Y12B-5, and C6025X24B-5. These models use the same size and the same bearing system and are tested at the same 70°C oven).

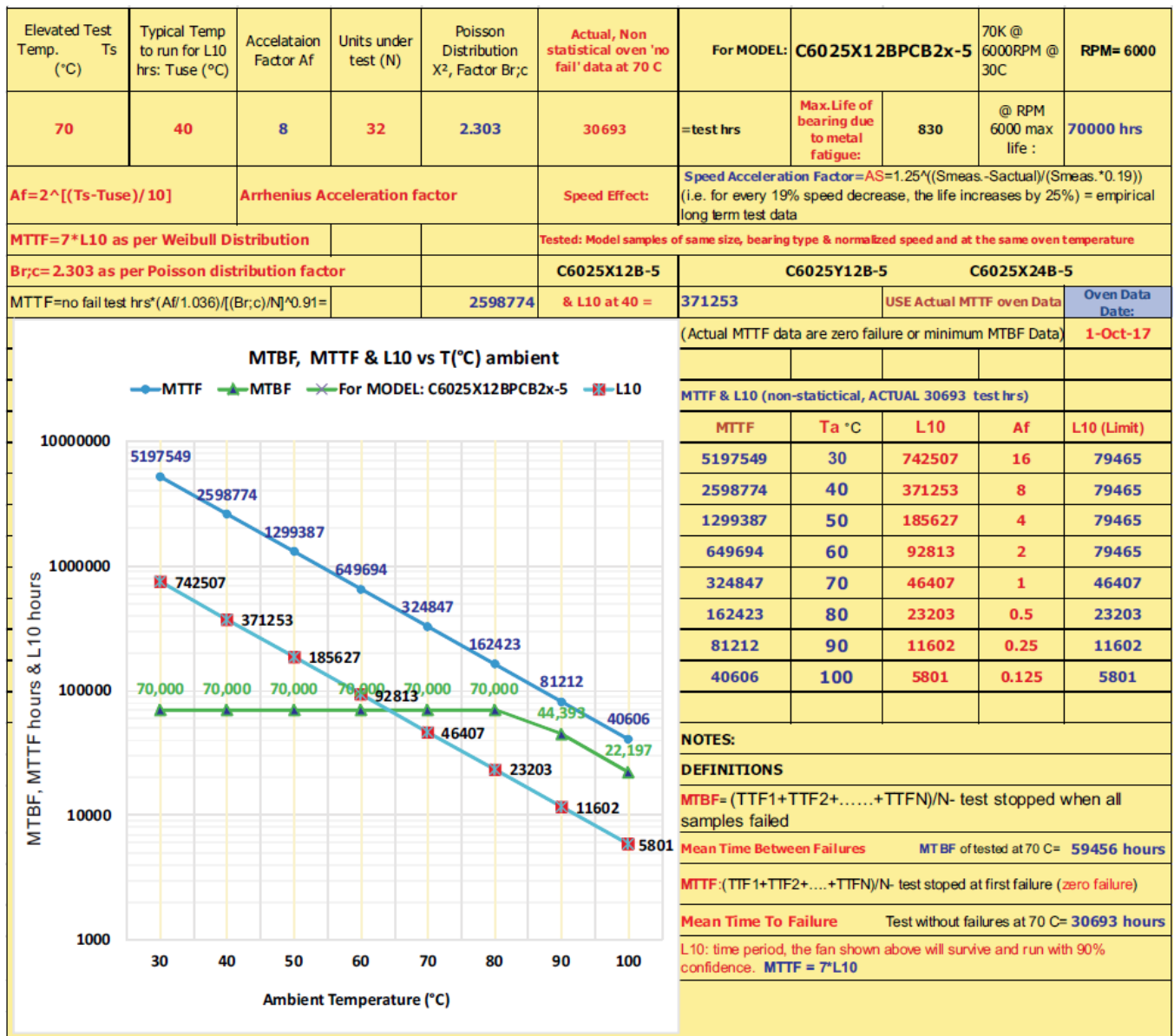

FAN MOTOR EFFICIENCY

The efficiency of a system is defined as $\eta = \text{Out Power} / \text{Input power}$

In the case of a motor, the incoming power in horsepower terms is expressed in electric power of watts equivalent to 746 W/hp (watts/horsepower) and the output power is in units of energy/second.

In the case of fans, the efficiency of the fan motor is measured in 2 different ways:

A. $(\eta = P*Q / W) = (\text{Pressure*Air Volume} / \text{Input Power}) = (\text{Output Power} / \text{Input Power})$

Where: P*Q is air flow power expressed in Watts if P is in Pascal (Pa), Q is the airflow in m³/sec and the Input Power is expressed in Watts.

The figure of efficiency varies according to the operating point of the fan. When there is no obstacle in the airflow (i.e. free air condition), we have the maximum airflow but the pressure presented to the airflow is zero. As a result, no actual benefit is provided and at this point the efficiency is zero. Likewise, when the airflow is totally blocked by closing the exhaust opening of the fan in which case we have the maximum pressure but zero airflow, the system's efficiency is also zero.

Below is a typical efficiency graph for fan model G1751H24B-5 indicating that the fan motor's efficiency for all the points from zero airflow-max pressure and zero pressure-max airflow.

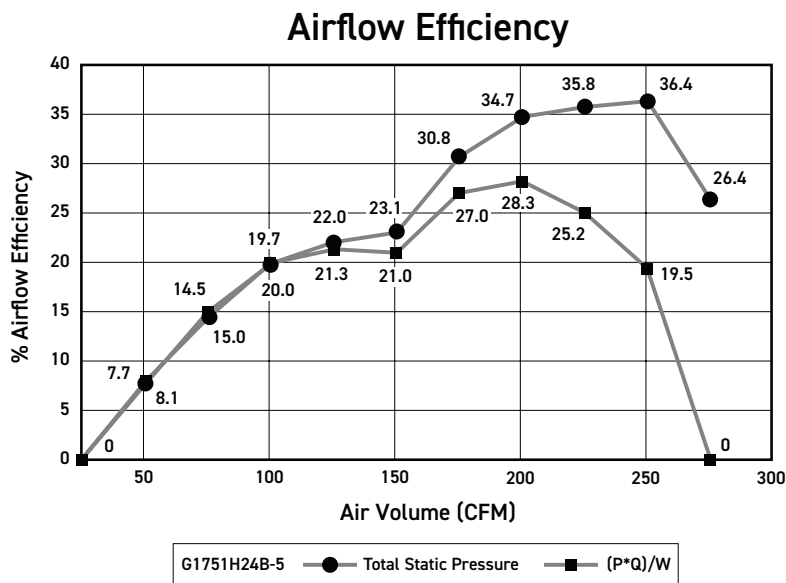

The units of measurement are:

Pressure in Pa (Pascal)

Air Volume: Q in m³/second

Input power is expressed in Watts

$[\eta = P*Q/W * 100\%]$

The above fan has peak airflow efficiency of 36.88% running at 3553 RPM and delivering 250.70 CFM. The free air, air volume of this fan is 280.1 CFM

B. $(\eta = P_t*Q / W)$, where: $P_t = P_s + P_d$

Where: P_s = Static Pressure

$P_d = m*V^2/2$ = dynamic pressure of the airflow

m = density of the air in kg/m³

V = is the airvelocity through the Blow Area in m/s

Blow area S in m² is the air exhaust area including the hub area.

$V = Q/S$ = Air volume / Blow area (where Air Volume Q is expressed in m³ / second)

Therefore $P_t = P_s + m*V^2/2 = P_s + [m*(Q/S)^2]/2$

AIRFLOW EFFICIENCY

DEFINITION OF AIRFLOW EFFICIENCY

The airflow efficiency of a fan motor is usually defined as the product of the airflow times the pressure at a given operating point divided by the power consumed by the fan motor: $\eta = \{(P \times Q) / W\} \times 100\%$
[P = Pascals, Q = m³ / sec, W = Watts]

AIRFLOW EFFICACY OF A FAN MOTOR

A fan motor is generally used for the purpose of cooling equipment or for circulating free air. In the case of equipment cooling, the airflow is restricted by airflow obstacles presented by the equipment (system impedance). Under zero pressure (free air), the fan motor can deliver the maximum airflow and under zero airflow conditions (max pressure), no air is passing through the equipment in order to remove heat. In neither of the above fan conditions the fan motor is of any use for cooling equipment purposes.

In order to determine the most efficient operating point of the fan motor engaged in cooling given equipment, we must calculate the maximum PQ product and thus determine the optimum ability of a given motor to cool. This can be illustrated by an example based on the PQ characteristic of a 1232 blower shown below:

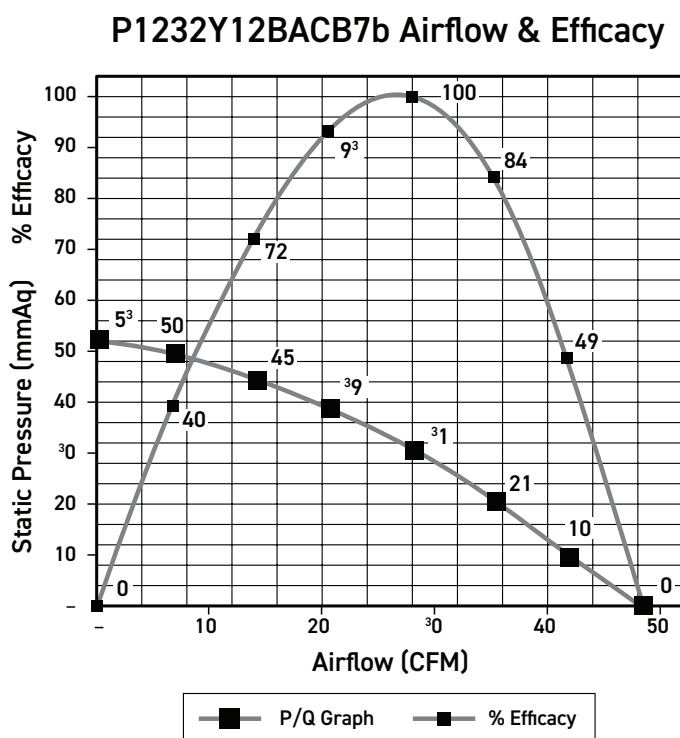

From the left side of the graph, we can see that if we accept over 80% efficacy, then the fan motor can optimally cool a system when it delivers 18 ~ 34 CFM under static pressure of the range 22~ 42 mmAq with optimum point of 24 ~ 30 CFM and pressure of 28 ~ 36 mmAq.

THE (PQ/W) CRITERION

In general, assuming materials used for DC fan motor production by manufactures is similar, and, assuming no significant construction shortcomings which will mainly have a bearing on the product life, the most important criterion remains the product's performance during its life span.

The fan motor's performance can be visualized by its PQ graph shown below:

PQ Characteristics of a typical fan motor

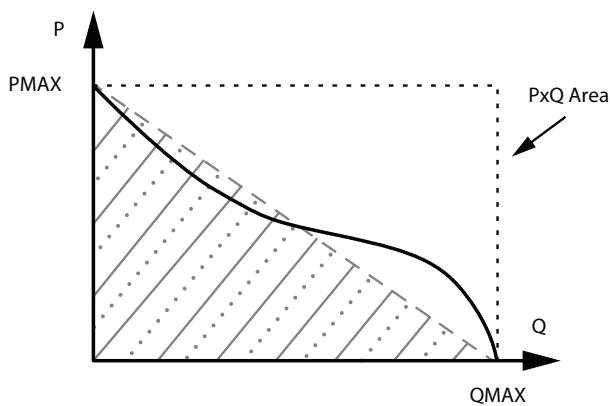

The higher the P and the higher the Q of a fan motor of a given size, the more airflow will be driven into the system to achieve better cooling results. However, at what cost is this accomplished? In order to appreciate the motor's performance, one must consider the product of P times Q result divided by the power that the product consumes. The lower the power dissipation for the highest possible PQ can characterize the fan motor's performance. If we were to draw a line from the maximum point of P and the maximum point of Q, we could easily determine the shaded area to be $(P \times Q)/2$. We could then define as performance criterion the $(P \times Q)/W$ which represents twice the shaded area divided by the consumed power.

One can argue that the power dissipation at maximum Q is lower than the power dissipated at maximum P for an axial fan motor, but for comparison reasons, this point becomes of less importance. It must also be noted that in the case of a blower type fan motor at maximum P, the power consumption is less than at maximum Q point. ***The higher the PQ/W, the better the fan motor's performance.***

THE (RPM/W) CRITERION

One other way to detect if the fan motor is properly designed and can perform under the lowest running temperature rise conditions is to check the ratio of RPM increase over the consumed power increase. As a rule, to increase the RPM by 10%, one needs to increase the power by about 30%. A well-designed fan motor will always stay below the 30% of power increase or else the motor is over driven, which will result in premature failure. To maintain this criterion, one needs to increase the silicon steel size or reduce the PQ performance of the product, or else the high running motor temperature will de rate the life of the product. ***Higher RPM/W means a more efficient and better designed fan motor.***

WHY ARE THE (PQ/W) AND (RPM/W) CRITERIA IMPORTANT?

Both of the above mentioned criteria are important and their value should be the highest possible because:

- They indicate how good the performance is for the running power cost.
- They indicate the lowest running temperature (which is proportional to the power input), which is inversely proportional to the product life. As a rule of thumb, the product life is reduced by 1/2 for every 10°C increase of its running temperature.

INNOVATION IN MOTION



1.888.546.0524 | 1.610.594.6000 | SALES@PELONISTECH.COM | PELONISTECHNOLOGIES.COM