

TITAN[®]

P1232-28 SERIES DC BLOWER

120 x 32mm



PELONISTECHNOLOGIES.COM

PTI **PELONIS**
TECHNOLOGIES INC.



TITAN® DC blowers are made for applications that require high performance cooling and protection from harsh weather conditions in outdoor and extreme environments. These rugged cooling products are also designed with “Intelligent Motion Controls” that improve efficiency and long-term reliability.

RUGGED DESIGN FOR EFFECTIVE COOLING

The P1232-28 series blower ensures effective cooling via an innovative 28-blade impeller design and an aluminum alloy AD12 die cast base that absorbs and disperses heat effectively. It also includes a single coil differential drive that is incorporated into the internal electronics to maximize airflow and pressure.

INTELLIGENT MOTION CONTROL

Each P1232-28 series blower model includes standard protection that enables the unit to restart if the impeller is blocked. Optional features include other “Intelligent Motion Controls” that can be added to the electronics to take full advantage of the blower’s performance and efficiency capabilities. These features include tachometer, rotation detection, life detection, pulse width modulation, automatic temperature control, current limit control, constant speed control, multiple alarm connections, and others. Various controls can also be programmed for custom output.

DUST & MOISTURE PROTECTION

IP51, IP54, IP56, or IP67 levels of dust and moisture protection can be applied to the blower’s exposed areas and internal electronics to protect applications that are used in severe to very harsh environmental conditions.

STANDARD FEATURES & SPECIFICATIONS

- 120 x 112 x 32mm (4.72 x 4.41 x 1.26in)
- 12V, 24V, 48V
- 23~43 CFM (0.65~1.22 m³/min)
- Dual Ball Bearings
- Aluminum AD12 Base with Stainless Steel Housing
- Thermoplastic Impeller PBT+15% GF, UL94-V0
- Lead Wires UL1007, 24 AWG, 250±10mm
- Auto Restart
- Locked Rotor Protection
- Stainless Steel Air Inlet Guard (optional)
- IP51 Dust & Moisture Protection
- Operating Temp -10°C to +70°C
- Operating Life 70,000 hours
- RoHS Compliant
- UL, cUL, CE

APPLICATIONS

HVAC
Compact Electronics
Medical Devices
Industrial Automation
Satellite Equipment
Automotive Products

The TITAN® P1232-28 series DC blower provides effective cooling in harsh environments and can be customized with optional controls and features that improve performance and efficiency to meet the most demanding requirements.

For additional information or for assistance with your application, contact us at sales@pelonistech.com.



**DESIGNED WITH
INTELLIGENT MOTION**

16 INNOVATIVE CONTROLS IMPROVE
PERFORMANCE AND EFFICIENCY

THE UNIQUE 28-BLADE DESIGN
MAXIMIZES AIRFLOW AND PRESSURE

CONTENTS

			Page
Model Number Specifications			1
Dimensional Drawings			2
Performance Curves			3
Electrical Specifications			4
Mechanical Specifications			4
Environmental Specifications			4
Intelligent Motion Controls and Environmental Protection Features Guide			5
Inrush Current Protection	1a	IR	6
Auto Restart	1b	AS	6
Tachometer/Frequency Generator	2a	FG	6
Rotation Detection	2b	RD	7
Rotation Detection Complement	2c	RD _b	7
Life Detection	2d	LD	7
Life Detection Complement	2e	LD _b	7
DC Voltage Signal Control	3a	VPWM	8
Current Source Signal Control	3b	IPWM	8
Pulse Width Modulation Signal Control	3c	PPWM	9
Over-Voltage Protection	4	OV	10
Automatic Temperature Control	5a	TPWM	10
Manual Variable Resistor Control	5b	RPWM	11
Current Limit Protection	6	CL	11
Fixed Constant Speed	7	CS _f	12
Programmable Constant Speed	7a	CS _p	12
Multi-Blower Alarm Connection			13
Dust & Moisture Protection			14
Conversion Tables & Notes			15

TITAN

P1232-28 SERIES DC BLOWER

120 x 112 x 32mm

(4.72 x 4.41 x 1.26in)



SPECIFICATIONS

- 12V, 24V, 48V
- 23~43 CFM (0.65~1.22 m³/min)
- Dual Ball Bearings
- Aluminum AD12 Base with Stainless Steel Housing
- Stainless Steel Air Inlet Guard (optional)
- Lead Wires: UL (+) Red; (-) Black, 24 AWG, 250±10mm
- Operating Temperature: -10°C ~ +70°C
- Operating Life: 70,000 hours

INTELLIGENT MOTION CONTROLS AND ENVIRONMENTAL PROTECTION FEATURES

Model Number	Curve	Voltage (V)	Range (VDC)	Label (A)	Current (A)	Power (W)	Speed (RPM)	Airflow (Q)		Pressure (P)		Noise (dBA)	INTELLIGENT MOTION CONTROLS AND ENVIRONMENTAL PROTECTION FEATURES																													
													Standard		Optional												IP54 PROTECTION	IP56 PROTECTION	IP67 PROTECTION													
													AUTO RESTART	IP51 PROTECTION	INRUSH CURRENT PROTECTION	TACHOMETER (Frequency Generator)	ROTATION DETECTION	ROTATION DETECTION COMPLEMENT	LIFE DETECTION	LIFE DETECTION COMPLEMENT	VOLTAGE SIGNAL CONTROL	CURRENT SIGNAL CONTROL	PWM CONTROL	OVER-VOLTAGE PROTECTION	AUTOMATIC TEMPERATURE CONTROL	VARIABLE RESISTOR CONTROL				CURRENT LIMIT PROTECTION	FIXED CONSTANT SPEED	PROGRAMMABLE CONSTANT SPEED										
1b (AS)	w	1a (IR)	2a (FG)	2b (RD)	2c (RDb)	2d (LD)	2e (LDb)	3a (VPWM)	3b (IPWM)	3c (PPWM)	4 (OV)	5a (TPWM)	5b (RPWM)	6 (CL)	7 (CSf)	7a (CSp)	w	w	w																							
P1232Y12BALB1b-28	⑤	12	7~14	3.250	1.700	20.40	5200	42.91	1.22	51.47	2.03	61.64																														
P1232X12BALB1b-28	④	12	7~14	2.132	1.350	16.20	4600	37.96	1.07	40.28	1.59	58.45																														
P1232H12BALB1b-28	③	12	7~14	1.261	0.940	11.28	4000	33.01	0.93	30.46	1.20	54.81	■	■	■	■	■	■	■	■	■	■	-	■	■	■	■	■	■	■	■	■	■	■	■	■	■	■	■	■	■	■
P1232M12BALB1b-28	②	12	7~14	0.806	0.577	6.92	3400	28.06	0.79	22.01	0.87	50.57																														
P1232L12BALB1b-28	①	12	7~14	0.442	0.322	3.86	2800	23.10	0.65	14.92	0.59	45.51																														
P1232Y24BALB1b-28	⑤	24	15~27	1.560	0.760	18.24	5200	42.91	1.22	51.47	2.03	61.64																														
P1232X24BALB1b-28	④	24	15~27	0.949	0.675	16.20	4600	37.96	1.07	40.28	1.59	58.45																														
P1232H24BALB1b-28	③	24	15~27	0.559	0.455	10.92	4000	33.01	0.93	30.46	1.20	54.81	■	■	■	■	■	■	■	■	■	■	-	■	■	■	■	■	■	■	■	■	■	■	■	■	■	■	■	■	■	■
P1232M24BALB1b-28	②	24	15~27	0.390	0.300	7.20	3400	28.06	0.79	22.01	0.87	50.57																														
P1232L24BALB1b-28	①	24	15~27	0.260	0.168	4.03	2800	23.10	0.65	14.92	0.59	45.51																														
P1232Y48BALB1b-28	⑤	48	30~57	0.560	0.400	19.20	5200	42.91	1.22	51.47	2.03	61.64																														
P1232X48BALB1b-28	④	48	30~57	0.420	0.336	16.13	4600	37.96	1.07	40.28	1.59	58.45																														
P1232H48BALB1b-28	③	48	30~57	0.290	0.221	10.61	4000	33.01	0.93	30.46	1.20	54.81	■	■	■	■	■	■	■	■	■	■	-	■	■	■	■	■	■	■	■	■	■	■	■	■	■	■	■	■	■	■
P1232M48BALB1b-28	②	48	30~57	0.190	0.150	7.20	3400	28.06	0.79	22.01	0.87	50.57																														
P1232L48BALB1b-28	①	48	30~57	0.120	0.084	4.03	2800	23.10	0.65	14.92	0.59	45.51																														

TITAN

P1232-28 SERIES DC BLOWER

120 x 112 x 32mm

(4.72 x 4.41 x 1.26in)

DIMENSIONAL DRAWINGS

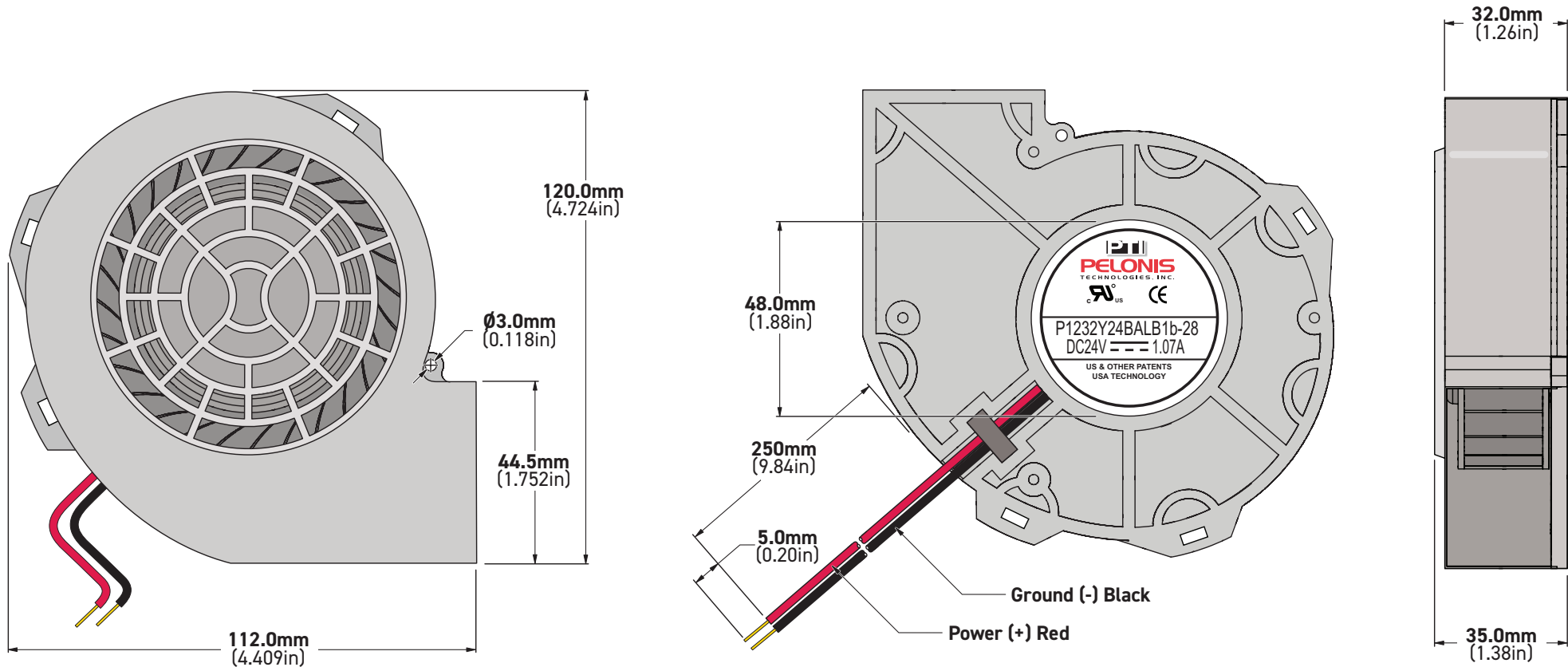

PERFORMANCE CURVES

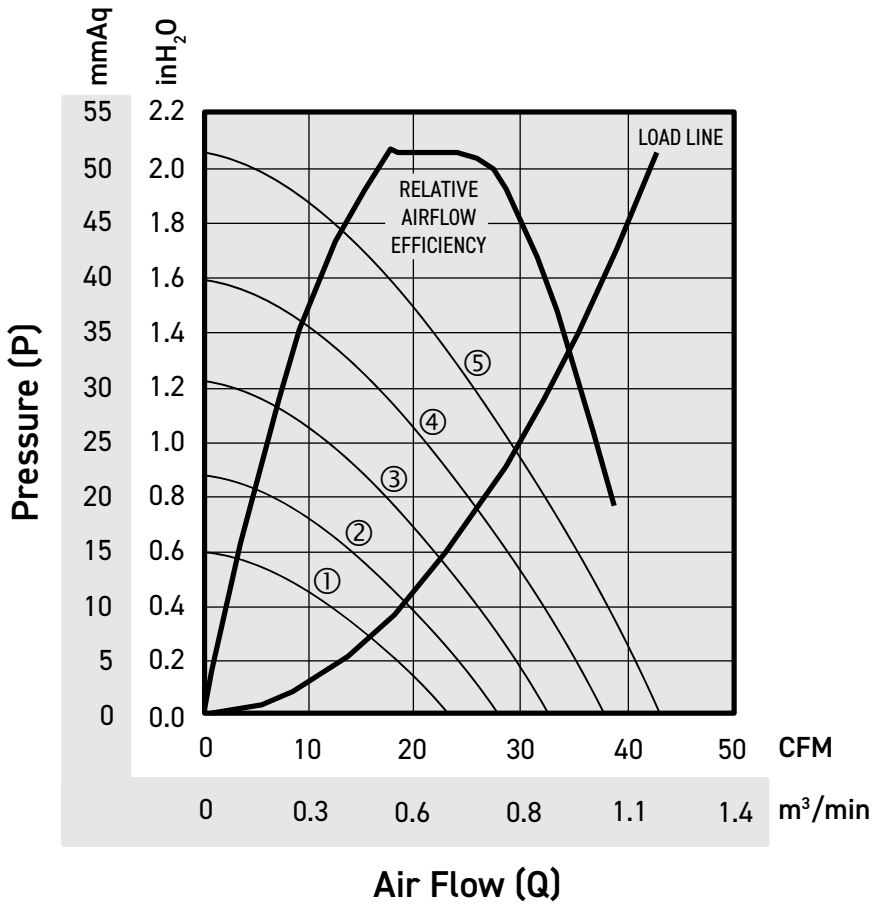

TITAN

P1232-28 SERIES DC BLOWER

120 x 112 x 32mm

(4.72 x 4.41 x 1.26in)

ELECTRICAL SPECIFICATIONS

Dielectric Strength	: 500 VAC / 1min, 600 VAC / 1sec maximum 1mA between power leads and frame.
Insulation Resistance	: $\geq 10M\Omega$ at 500 VDC between frame and (+/-) lead wires.
Motor	: Brushless DC
Locked Rotor Protection	: Blower will automatically restart in max 4 seconds after motor is released from locked condition.

MECHANICAL SPECIFICATIONS

Airflow Direction	: Air over struts
Frame	: Aluminum AD12 Base/Stainless Steel Housing
Impeller	: Thermoplastic PBT+15% GF, UL94-V0
Bearings	: Dual Ball Bearings
Lead Wires	: UL1007, 24 AWG, Red (+), Black (-), 250±10mm
Life Expectancy	: 70,000 hrs. at 25°C, 65% RH
Weight	: 330g (11.6oz)

ENVIRONMENTAL SPECIFICATIONS

Operating Temperature	: -10°C to +70°C @ 45%-85%RH
Storage Temperature	: -40°C to +90°C
Acoustical	: At rated voltage, in free air; background noise 16.8 dBA. 1 microphone is placed at a distance of one meter from the intake.
RoHS Compliance	: Hazardous substance contents are in compliance with RoHS 2011/EC requirements.

TITAN

P1232-28 SERIES DC BLOWER

120 x 112 x 32mm

(4.72 x 4.41 x 1.26in)

INTELLIGENT MOTION CONTROLS AND ENVIRONMENTAL PROTECTION FEATURES GUIDE

CONTROL/FEATURE	STANDARD	OPTIONAL	NOT AVAILABLE	#	CODE	DESCRIPTION	WIRE COLOR	PAGE
Inrush Current Protection		■		1a	IR	Protects from Current surges. At startup, the current is applied gradually (soft start).	-	6
Auto Restart	■			1b	AS	The Current is reduced to zero when the blower is blocked and the blower attempts to restart every few seconds.	-	6
Tachometer (Frequency Generator)		■		2a	FG	An output signal is provided in order to monitor the blower's running speed.	Yellow	6
Rotation Detector		■		2b	RD	Detects whether the blower is rotating. A LOW output signal indicates that the blower is rotating.	Gray	6
Rotation Detector Complement		■		2c	RDb	Detects whether the blower is rotating. A HIGH output signal indicates that the blower is rotating.	Violet	7
Life Detection		■		2d	LD	LOW output signal indicates RPM is <70% of rated speed (indicates aging blower of many connected in parallel).	Brown	7
Life Detection Complement		■		2e	LDb	This function is the complement of the LD Control applied in one blower.	Brown	7
DC Voltage Signal Control		■		3a	VPWM	The blower speed is controlled by applying a DC Voltage signal. Standard DC signal is 0 to 5V.	White	8
DC Current Signal Control		■		3b	IPWM	The blower speed is controlled by applying a DC Current signal (e.g. 4 to 20mA or 20 to 50mA).	White	8
Pulse Width Modulation Control		■		3c	PPWM	The blower speed is controlled by applying a PWM signal with frequency from 30Hz to 30KHz.	Blue	9
Over-Voltage Protection			-	4	OV	The blower is protected if the applied voltage is up to twice the rated operating voltage.	-	10
Automatic Temperature Control		■		5a	TPWM	The blower speed is controlled by temperature sensed by a Thermistor (NTC). Standard NTC 100K@25C, B=4484.	Green	10
Variable Resistor Control		■		5b	RPWM	The blower speed is controlled by manually varying the external resistor (Min VR = 10K, Max VR = 100K).	Orange + White	11
Current Limit Protection		■		6	CL	The current is limited at startup mode (typically less than twice the rated current).	-	11
Fixed Constant Speed		■		7	CSf	The blower speed is independent of the power supply above the rated voltage (factory preset).	-	12
Programmable Constant Speed		■		7a	CSp	The desired maximum fan speed can be selected externally for less than the rated values.	Orange + White	12
Multi-Blower Alarm Connection		■		-	-	Alarm indicator when any blower has stopped running in an array of connected blowers.	-	13
IP51 Protection	■			w	IP51	Limited protection from dust and condensation.	-	14
IP54 Protection		■		w	IP54	Protection from dust and water spray from any direction.	-	14
IP56 Protection		■		w	IP56	Protection from dust and high pressure water jets from any direction.	-	14
IP67 Protection		■		w	IP67	Total protection from dust and water immersion.	-	14

1a IR INRUSH CURRENT PROTECTION

OPTIONAL CONTROL

With the Inrush Current Protection (IR) Control, when the power switch is turned on to supply current to the blower, the current is zero and starts to increase gradually until the blower has achieved its maximum speed at the rated current. The maximum current at startup is equal to the free-running current (or less when the rotor stays locked at startup). The blower will achieve the rated speed within 10 seconds. This built-in Control contains no external wire. **End Result Benefit:** Protects from Current surges.

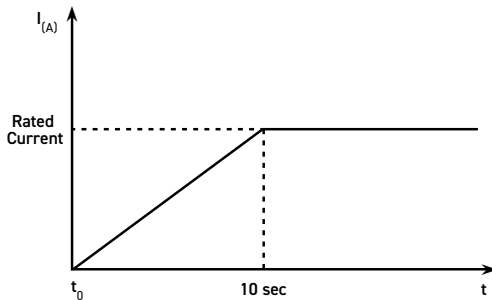

1b AS AUTO RESTART

STANDARD CONTROL

The Auto Restart (AS) Control feature ensures that the blower will automatically restart if the blade is blocked and then released. When the rotor is locked, the blower current is reduced to zero and the blower tries to restart every 5 seconds. This is a built-in Control with no external wire. **End Result Benefit:** Protects automatically if the blade gets blocked.

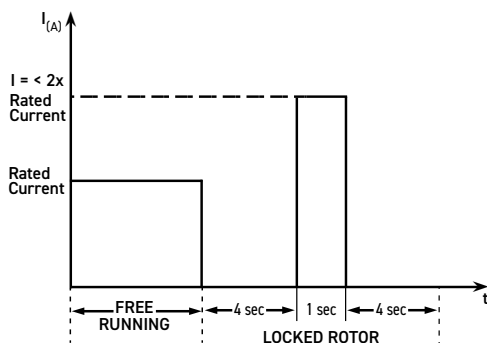

2a FG TACHOMETER (FREQUENCY GENERATOR)

OPTIONAL CONTROL

The Frequency Generator (FG) Control is an open collector output type. It provides a square wave signal if the open collector is connected to a "PULL UP" resistor and is powered by the power supply voltage which is compatible with the input of the reading device (such as TTL input of the computer etc.). The maximum collector voltage may be up to 72V DC and the maximum collector current is 10mA. The reading device's power supply must have the same ground potential as the blower. The FG Control is an external YELLOW wire. **End Result Benefit:** Monitors the blower's running speed.

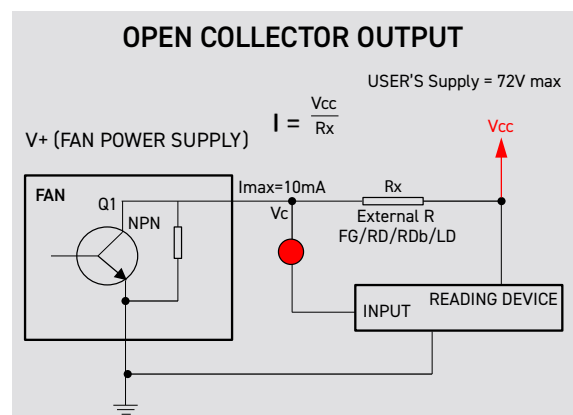
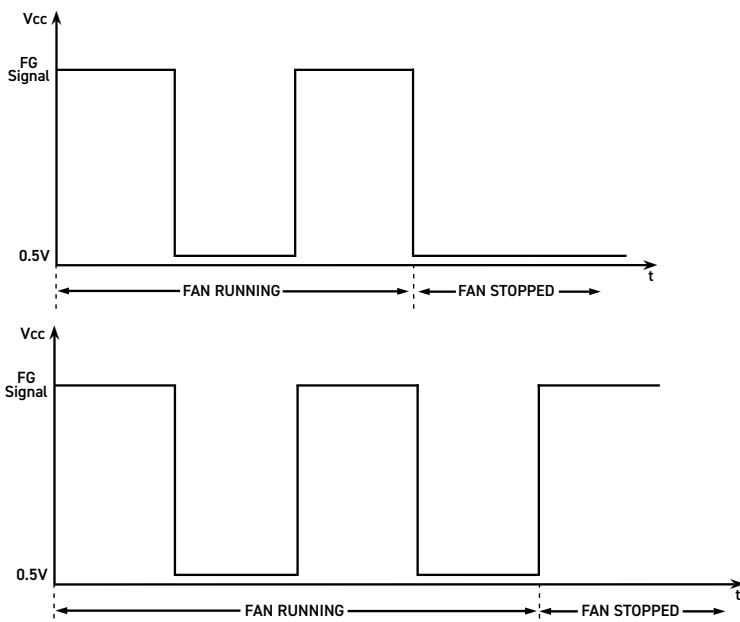

TITAN

P1232-28 SERIES DC BLOWER

120 x 112 x 32mm

(4.72 x 4.41 x 1.26in)

2b RD ROTATION DETECTION

OPTIONAL CONTROL

The Rotation Detection (RD) Control is an open collector type. It contains the same hardware as the Frequency Generator Control 2a. The output signal is LOW when the blower is rotating and is set HIGH when the blower is stopped or is powered OFF. The RD Control is an external GRAY wire. **End Result Benefit:** Indicates if the blade is rotating (LOW signal).

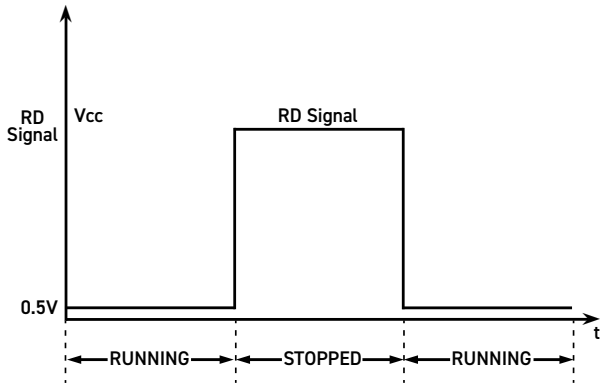

2c RDb ROTATION DETECTION COMPLEMENT

OPTIONAL CONTROL

The Rotation Detector Complement (RDb) Control is an open collector type with the same hardware as the Frequency Generator Control 2a. The output signal is HIGH when the blower is rotating and is set LOW when the blower is stopped or is powered OFF. This output can be connected in parallel to the RDb of an array of blowers that ends at a single alarm device to warn when any blower has stopped (see the Multi-Blower Alarm Connection on page 13). The RDb Control is an external VIOLET wire. **End Result Benefit:** Indicates if the blade is rotating (HIGH signal).

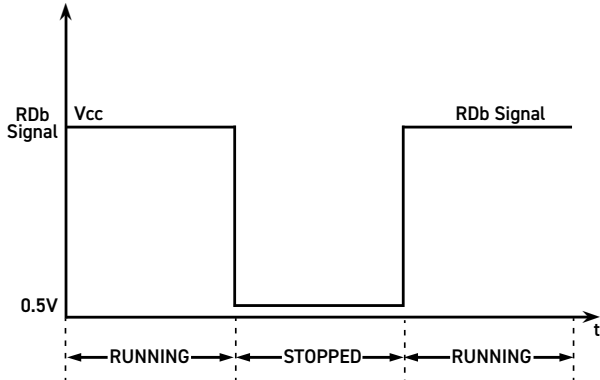

2d LD LIFE DETECTION

OPTIONAL CONTROL

The Life Detection (LD) Control is an open collector type with the same hardware as the Frequency Generator Control 2a. The output signal is HIGH when the blower is rotating normally and it is LOW when the blower is turning below 70% of its rated target speed. Slow rotation may indicate aging or wear of the blower or reduced power supply voltage. The LD Control is a BROWN external wire. **End Result Benefit:** Indicates if the blade is rotating (HIGH signal).

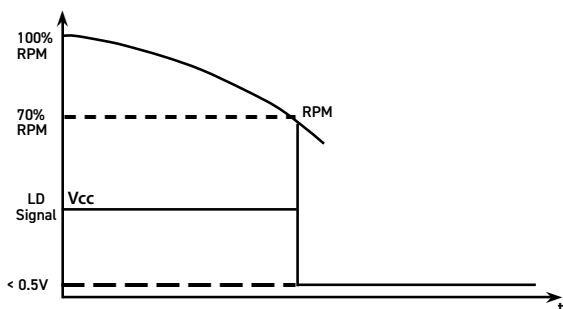

2e LDb LIFE DETECTION COMPLEMENT

OPTIONAL CONTROL

This function is the complement of the LD Control applied in one blower. **End Result Benefit:** Indicates if the blade is rotating (LOW signal).

3a VPWM DC VOLTAGE SIGNAL CONTROL

OPTIONAL CONTROL

The DC Voltage Signal (VPWM) Control adjusts the speed when applying an external DC Voltage signal. This voltage input “Vin” may have any value from 1V to 20V (standard value is 1V to 5V). The blower speed will vary linearly and is proportional to the % change of the “Vin” value, corresponding to the same % change of the maximum speed.

The Constant Speed (CS), Inrush Current Protection (IR), and Current Limit (CL) controls are included. The part number is followed by additional identification entry such as V 1 5 20 100 C 500: This means the blower speed will be 1,000 RPM (20%) at 1V and 5,000 RPM (100%) at 5V. The blower will maintain the minimum speed if Vin < 1V and it will stop if Vin < 0.5V (Mode “C” operation). The maximum blower speed is 5,000 RPM, and the stop point is typically set at 20% of the maximum. The VPWM Control is an external WHITE wire. (See Mode A, B, C) Slope: 1000 RPM/volt. **End Result Benefit:** Controls speed via an external DC voltage signal.

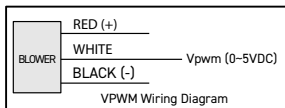

VPWM-pos-slope 2008/7/16
RPM: 882 to 5000
Vs: 1.8 to 10 Volts
VPWM 1.8 10 18 100 A 500
MODE: TYPE- A change @: -0.2 V
ST 12% 1.65 D 0.2 F 2 C

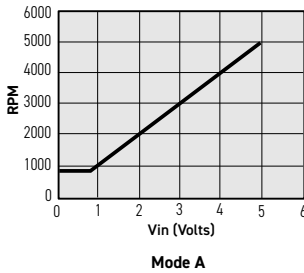

VPWM-pos-slope 2008/7/16
RPM: 882 to 5000
Vs: 1.8 to 10 Volts
MODE: TYPE- B change @: 1.78 V
VPWM 1.8 10 18 100 B 500
ST 12% 1.65 D 0.2 F 2 C

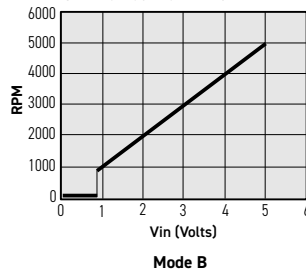

VPWM-pos-slope 2008/7/16
RPM: 882 to 5000
Vs: 1.8 to 10 Volts
VPWM 1.8 10 18 100 C 500
MODE: TYPE- C change @: 0.8 V
ST 12% 1.65 D 0.2 F 2 C

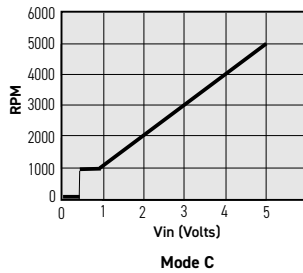

* Select from Mode A, Mode B, or Mode C, or specify required function.

3b IPWM CURRENT SOURCE SIGNAL CONTROL

OPTIONAL CONTROL

The Current Source Signal (IPWM) Control adjusts the speed by applying an external Current Source Signal. This current input “Iin” may have any value from 4 mA to 50 mA, (standard value is 4 to 20mA). The blower speed will vary linearly and is proportional to the % change of the Iin value, corresponding to the same % change of the maximum speed.

The Constant Speed (CS), Inrush Current Protection (IR), and Current Limit (CL) controls are included. The part number is followed by additional identification entry such as I 4 20 20 100 A 500. This means that the blower speed will be 1,000 RPM (20%) at 4mA and 5,000 RPM (100%) at 20mA. The blower will maintain the minimum speed if Iin < 4mA (Mode “A” operation). The maximum blower speed is 5,000 RPM. The IPWM Control is an external WHITE wire. (See Mode A, B, C) Slope: 266 RPM/mA.

End Result Benefit: Controls speed via an external Current source signal.

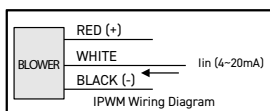

IPWM
RPM: 1000 ~ 5000
I in: 4.0 ~ 20.0mA
MODE: TYPE-A Stop @: 0.0mA
IPWM 4 20 20 100 A 500

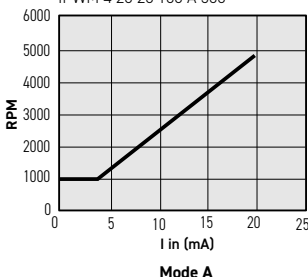

IPWM
RPM: 1000 ~ 5000
I in: 4.0 ~ 20.0mA
MODE: TYPE-B Stop @: 4.0mA
IPWM 4 20 20 100 B 500

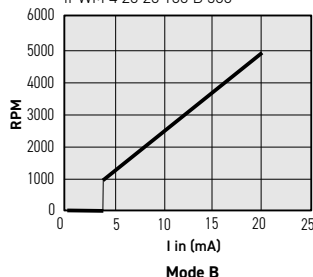

IPWM
RPM: 1000 ~ 5000
I in: 4.0 ~ 20.0mA
MODE: TYPE-C Stop @: 1.96mA
IPWM 4 20 20 100 C 500

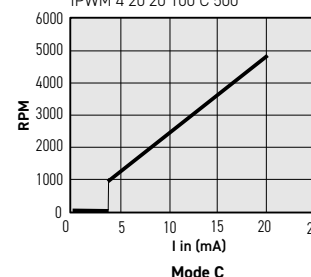

* Select from Mode A, Mode B, or Mode C, or specify required function.

3c PPWM PULSE WIDTH MODULATION SIGNAL CONTROL

OPTIONAL CONTROL

The Pulse Width Modulation Signal (PPWM) Control adjusts the speed by applying a pulse width modulated signal. The frequency may be in the range of 30 Hz to 30 KHz. The maximum pulse height "HIGH" may be from 3V to 10V. The maximum pulse height "LOW" is 0.4V. The blower speed will vary linearly and is proportional to the % change of the Duty Cycle value, corresponding to the same % change of the maximum speed.

The Constant Speed (CS), Inrush Current Protection (IR), and Current Limit (CL) controls are included. The part number is followed by additional identification entry such as P 25 80 25 80 C 393 Cs320. This means that the blower speed will be 1,000 RPM (25%) at 25% Duty Cycle and 3,200 RPM (80%) at 80% Duty Cycle. Furthermore, the blower will maintain the minimum speed if the Duty Cycle is less than 25% (Mode "A" operation). The maximum possible blower speed is 4000 RPM. (See Mode A, B, C) Slope: 36.4 RPM/%PWM. **End Result Benefit:** Controls speed by applying a PWM signal 30Hz to 30KHz.

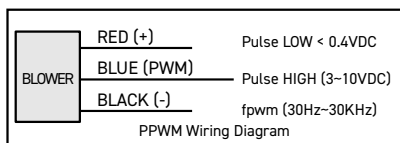

PPWM-pos-slope 2008/7/15

RPM: 988 to 3200
 %PPWM 24.7% to 80.0%
 MODE: TYPE- A change @: -2.0%
 PPWM 24.8 80 25 80 A 320 CN-010-012
 ST 12% 1.65 D 0.2 F 2 C - CN-010-012

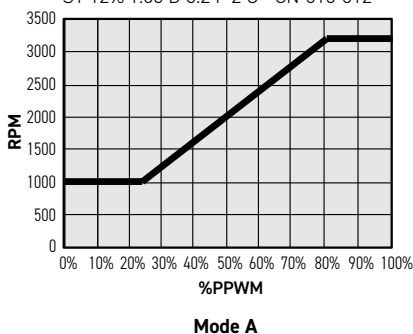

PPWM-pos-slope 2008/7/15

RPM: 988 to 3200
 %PPWM 24.7% to 80.0%
 MODE: TYPE- B change @: 25.0%
 PPWM 24.8 80 25 80 B 320 CN-010-012
 ST 12% 1.65 D 0.2 F 2 C - CN-010-012

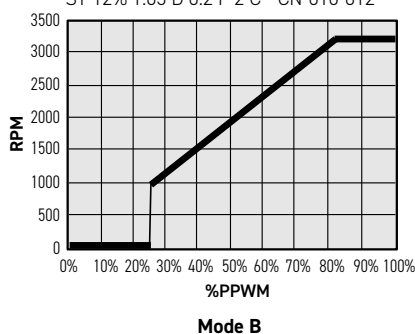

PPWM-pos-slope 2008/7/15

RPM: 988 to 3200
 %PPWM 24.7% to 80.0%
 MODE: TYPE- C change @: 10.0%
 PPWM 24.8 80 25 80 C 320 CN-010-012
 ST 12% 1.65 D 0.2 F 2 C - CN-010-012

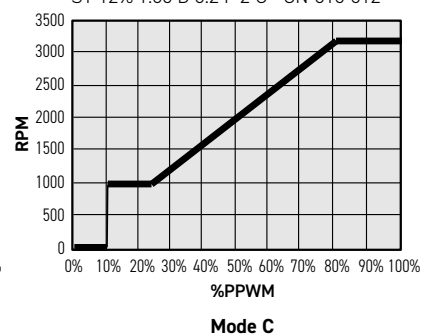

* Select from Mode A, Mode B, or Mode C, or specify required function.

4 OV OVER VOLTAGE PROTECTION

OPTIONAL CONTROL

This Over-Voltage Protection (OV) Control detects the power supply voltage and allows operation up to the rated maximum operating voltage. Typically, the maximum operating voltage is 20% over the specified rated voltage (unless otherwise specified).

If the power supply voltage increases over the 20% limit, the blower will stop running and the power supply current will be reduced to essentially zero. The maximum over-voltage protection range is twice the value of the rated voltage. For example, if the rated voltage is 24V, the maximum voltage that can be applied accidentally is 48V. The same applies to a 12V blower; the maximum applied over-voltage is 24V. The OV Control comes built-in with no external wire. **End Result Benefit:** Protects from power supply over-voltage.

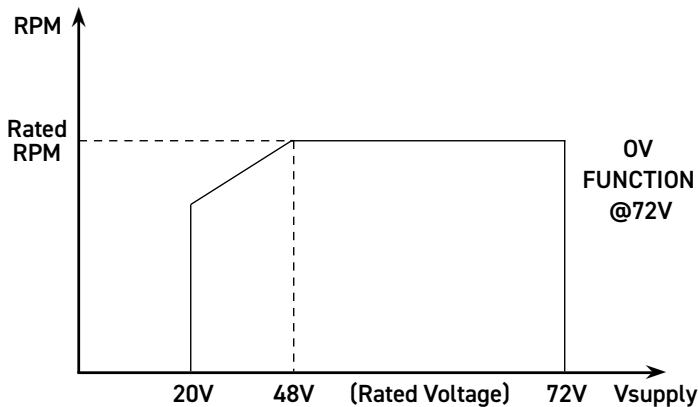

5a TPWM AUTOMATIC TEMPERATURE CONTROL

OPTIONAL CONTROL

When the Automatic Temperature (TPWM) Control is applied, the upper and lower temperatures may be selected as well as the choice of maintaining the minimum RPM below the minimum temperature chosen. The Constant Speed (CS), Inrush Current Protection (IR), and Current Limit (CL) controls are included.

The NTC thermistor is a 104J (100K @ 25 °C) type and is included with the blower (either “built-in” or external). The part number is followed by additional identification entry such as T 16 40 20 100 A 500. This means that the blower speed will be 1,000 RPM (20%) at 16 °C and 5,000 RPM (100%) at 40 °C. The blower will maintain the minimum speed of 1,000 RPM below the temperature of 16 °C (Mode “A” operation). For safety reasons, if the NTC thermistor is OPEN or SHORTED, the blower will run at its maximum speed. The TPWM Control is an external GREEN wire. Mode A, B, and C show the three available modes of control.

End Result Benefit: Controls speed automatically via a temperature sensor.

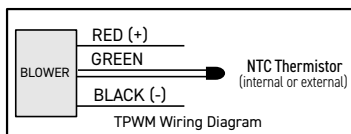

TPWM (ntc to GND) 07/16/08

RPM: 1000 to 5000
MODE: A
TPWM (ntc to GND) 15 40 20 100 A 500
Temp.(°C) 15.0 to 40.0
ST 6% 1.65 D 0.2 F 1 A - CN-010-021

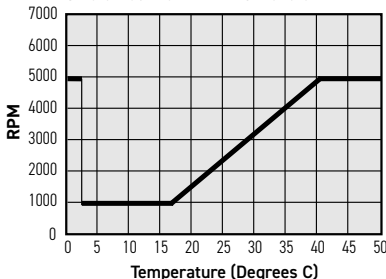

Mode A

TPWM (ntc to GND) 07/16/08

RPM: 1000 to 5000
MODE: B
TPWM (ntc to GND) 15 40 20 100 B 500
Temp.(°C) 15.0 to 40.0
ST 6% 1.65 D 0.2 F 1 A - CN-010-021

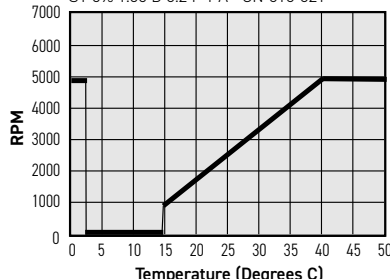

Mode B

TPWM (ntc to GND) 07/16/08

RPM: 1000 to 5000
MODE: C Stop @: 5 °C
TPWM (ntc to GND) 15 40 20 100 C 500
Temp.(°C) 15.0 to 40.0
ST 6% 1.65 D 0.2 F 1 A - CN-010-021

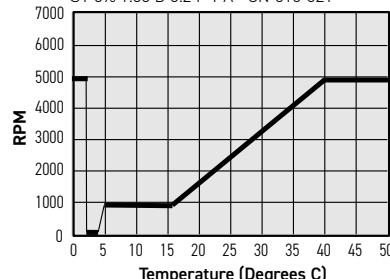

Mode C

* Select from Mode A, Mode B, or Mode C, or specify required function.

5b RPWM MANUAL VARIABLE RESISTOR CONTROL

OPTIONAL CONTROL

With the Manual Variable Resistor (RPWM) Control, the speed can be controlled using an external variable resistor. This resistor may have any maximum value from 10K to 100K. The blower speed will vary linearly and is proportional to the % change of the resistor value, corresponding to the same % change of the maximum speed.

The Constant Speed (CS), Inrush Current Protection (IR), and Current Limit (CL) controls are included. The part number is followed by additional identification entry such as R 25 100 25 100 B 400. This means if VR = 100K, the blower speed will be 1,000 RPM (25%) at VR = 25K and 4,000 RPM. (100%) at VR = 100K. The blower will stop if VR < 25K (Mode "B" operation). The maximum fan speed is 4,000 RPM. The RPWM Control is an external ORANGE and WHITE wire. (See Mode A,B, C) Slope: 40 RPM / %R, (If VR=10K: 400RPM/KΩ, If VR=50K: 80RPM/KΩ).

End Result Benefit: Controls speed manually via an external resistor.

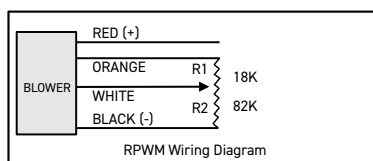

RPWM-pos-slope 2008/7/16

RPM: 988 to 4000
 %R= 24.7% to 100.0%
 RPWM 24.8 100 25 100 A 400
 ST 12% 1.65 D 0.2 F 2 C - CN-010-013
 MODE: TYPE- A change @: -2.0%

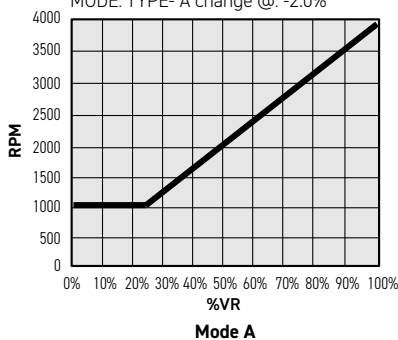

RPWM-pos-slope 2008/7/16

RPM: 988 to 4000
 %R= 24.7% to 100.0%
 RPWM 24.8 100 25 100 B 400
 ST 12% 1.65 D 0.2 F 2 C - CN-010-013
 MODE: TYPE- B change @: 25.0%

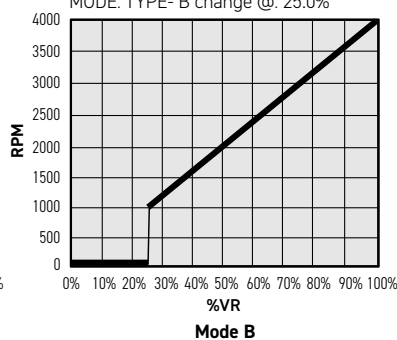

RPWM-pos-slope 2008/7/16

RPM: 988 to 4000
 %R= 24.7% to 100.0%
 MODE: TYPE- C change @: 10%
 RPWM 24.8 100 25 100 C 400
 ST 30% 2 D 3.2 F 3 fD - CN-010-032

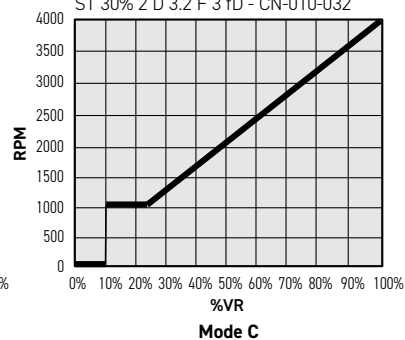

* Select from Mode A, Mode B, or Mode C, or specify required function.

6 CL CURRENT LIMIT CONTROL

OPTIONAL CONTROL

With the Current Limit (CL) Control, the current is limited during the start or restart (AS) period (refer to the Auto Restart feature on page 6). The CL Control comes built-in with no external wire.

End Result Benefit: Limits Current during start or restart period.

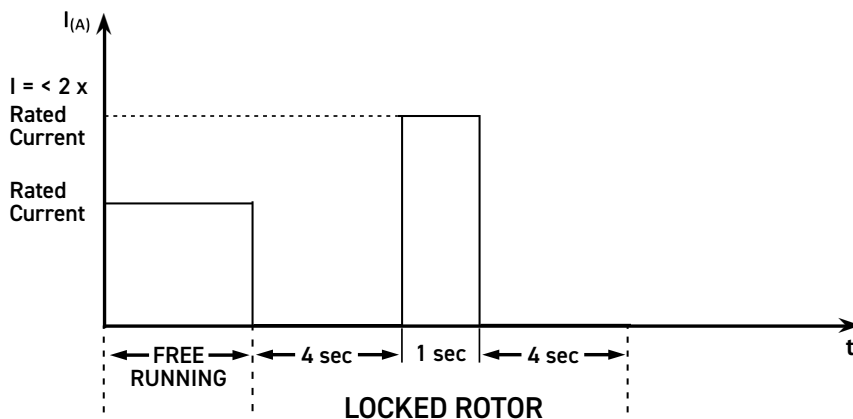

7 CS_f FIXED CONSTANT SPEED

OPTIONAL CONTROL

The Fixed Constant Speed (CS_f) Control allows the blower to operate safely over a very large power supply voltage range. For example, if the blower is designed to run at 4200 RPM at the rated voltage of 48 Volts, the blower will maintain the same RPM even when the supply voltage varies from 48 to 72 Volts.

The fixed CS Control is preset internally and the maximum RPM is the rated RPM. The Fixed CS Control is built-in with no external wire. **End Result Benefit:** Maintains a constant speed over a wide voltage range.

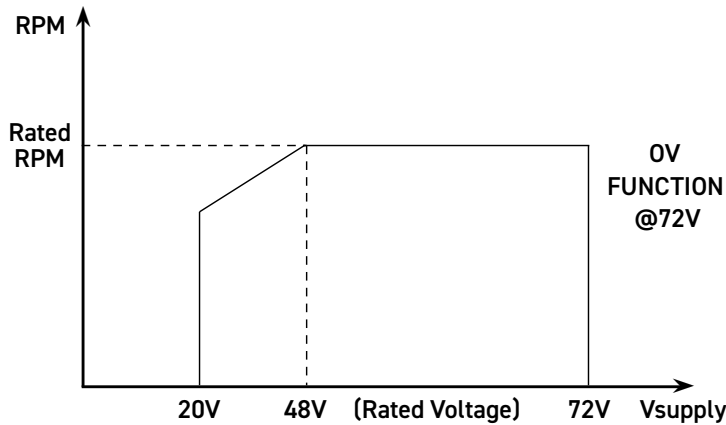

7a CS_p PROGRAMMABLE CONSTANT SPEED

OPTIONAL CONTROL

The Programmable Constant Speed (CS_p) Control can be implemented by the use of the RPWM Control. For example, if the external resistor is made up by an 82K and an 18K resistor, then the center point of these resistors will be the input which will determine that 82% of the rated speed will be the maximum speed of the modified blower (if the resistor ends are reversed, then 18% of the rated speed will be the new maximum speed).

The resistor ends are tied to the ORANGE and BLACK wires and the center point is tied to the WHITE input wire. A very important use of this control is to overcome system impedance variations. The blower can be programmed to run at 20% lower of the rated speed at zero pressure. When the blower's static pressure is increased, the blower will be able to maintain the same speed under maximum pressure, thus becoming immune to system impedance variations. The Programmable CS Control is an external ORANGE and WHITE wire. **End Result Benefit:** Maintains a constant speed over a wide voltage range.

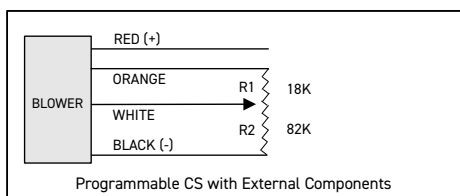

Q1 is the maximum airflow without CS adjustment.
 Q2 is the maximum airflow reduced with R1 and R2 setup.
 P2, P1 when the maximum speed is selected to set Q2 at about 80% of Q1.

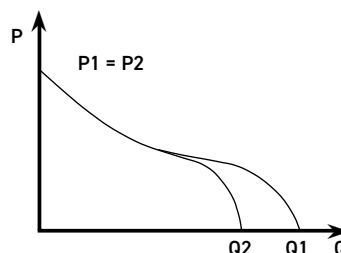
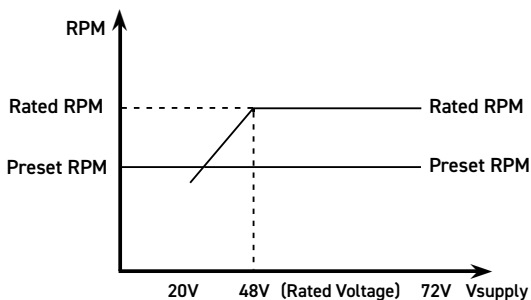

TITAN

P1232-28 SERIES DC BLOWER

120 x 112 x 32mm

(4.72 x 4.41 x 1.26in)

MULTI-BLOWER ALARM CONNECTION

OPTIONAL CONTROL

When multiple blowers are used in an application, it is critical to monitor the proper running state of the blowers. It is practical to have a single alarm (sound or light) that will indicate when any of the blowers have stopped running.

Every blower can include the Rotation Detector Complement (RDb) Control in order to combine the multi-alarm function to a single alarm indicator. The diagram below shows how to connect the multi-alarm any number of blowers of any model equipped with the RDb Control cascaded (maximum 100 blowers).

NOTE: If the engineer wants to connect to a voltage higher than 35V for his alarm signal, an R2 resistor may be added. If the blowers have the Life Detection (LD) Control output and one blower runs below 70% of its rated speed, the alarm will be activated.

End Result Benefit: Monitors the running state of multiple blowers.

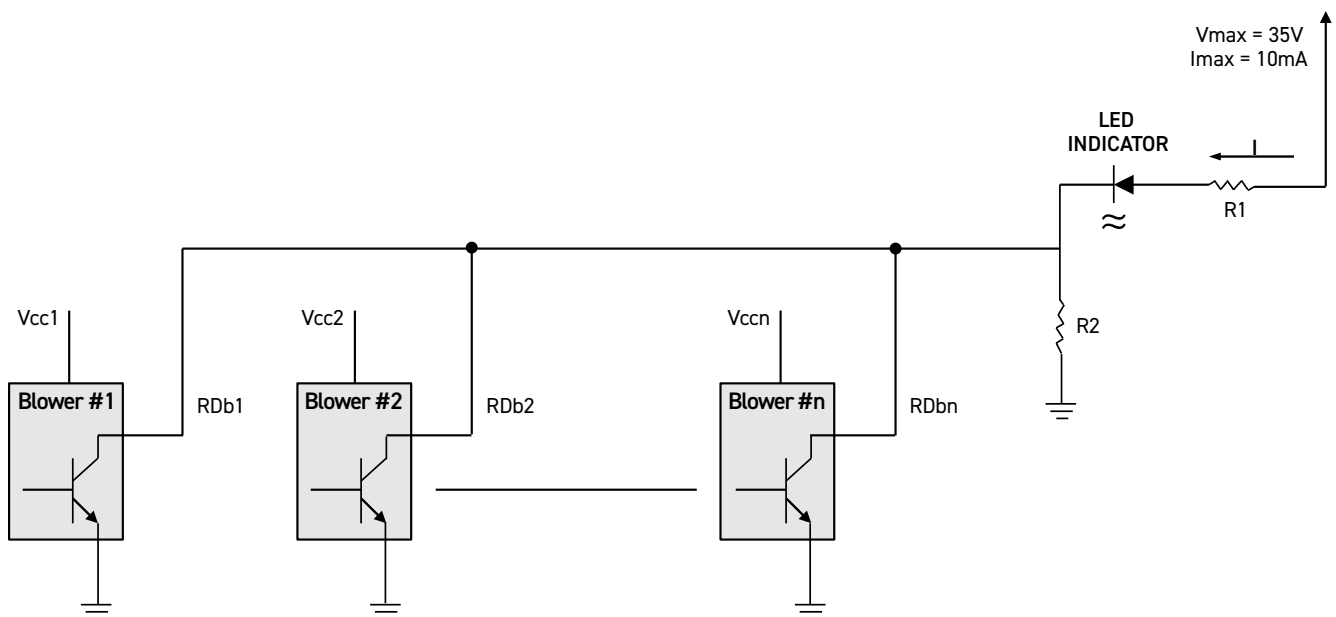

INGRESS PROTECTION (IP)

Ingress Protection (IP) indicates the level of protection against intrusion from dust and moisture.

IP51 (standard)	: Limited protection from dust and condensation.
IP54 (optional)	: Protection from dust and water spray from any direction.
IP56 (optional)	: Protection from dust and high pressure water jets from any direction.
IP67 (optional)	: Total protection from dust and water immersion.

STATIC PRESSURE CONVERSION TABLE

Pa (=N/m ²)	mmH ₂ O = mmAq	inH ₂ O	Kgf/cm ²	bar
1	1.0197 x 10 ⁻¹	4.017 x 10 ⁻³	1.0197 x 10 ⁻⁵	1 x 10 ⁻⁵
9.80665	1	3.939 x 10 ⁻²	1 x 10 ⁻⁴	9.80665 x 10 ⁻⁵
1.3332 x 10 ²	1.3619 x 10	1	1.3595 x 10 ⁻³	1.3332 x 10 ⁻³
9.80665 x 10 ⁴	10 ⁴	3.937 x 10 ²	1	9.80665 x 10 ⁻¹
1 x 10 ⁵	1.0197 x 10 ⁴	4.018 x 10 ²	1.01972	1

AIR FLOW CONVERSION TABLE

m ³ /min	CFM	L/s	L/min
1	3.531 x 10	1.666 x 10	1 x 10 ³
2.831 x 10 ⁻²	1	4.720 x 10 ⁻¹	2.831 x 10
6 x 10 ⁻²	2.118	1	6 x 10
1 x 10 ⁻³	3.531 x 10 ⁻²	1.666 x 10 ²	1

FAHRENHEIT/CELSIUS/KELVIN CONVERSION TABLE

Fahrenheit to Celsius	Celsius to Fahrenheit	Celsius to Kelvin
°C = (5/9) * (°F-32)	°F = (°C * (9/5)) + 32	K = °C + 273.15

NOTES:

INNOVATION IN MOTION



1.888.546.0524 | 1.610.594.6000 | SALES@PELONISTECH.COM | PELONISTECHNOLOGIES.COM